

Competitors

#	Name	Grade	Club	1	2	3	Wins	Pts	Pos
1	SHEARER Lola	Orange	Steveston Judo Club	XX			0	0	3
2	DANILKOV Ekaterina	Orange	Burnaby Judo Club	10	XX	10	2	20	1
3	VAN ZYL Carla	Orange	Hart Judo Academy	5		XX	1	5	2

Matches

Match	White			Blue	Result	Time	Code
B-62	SHEARER Lola	1	2	DANILKOV Ekaterina	0 - 10	0:14	IPO
B-68	SHEARER Lola	1	3	VAN ZYL Carla	0 - 5	3:00	WAZ
B-74	DANILKOV Ekaterina	2	3	VAN ZYL Carla	10 - 0	0:00	IPO

Results

Pos	Name
1	DANILKOV Ekaterina, Burnaby Judo Club
2	VAN ZYL Carla, Hart Judo Academy



U14 Female -44Kg

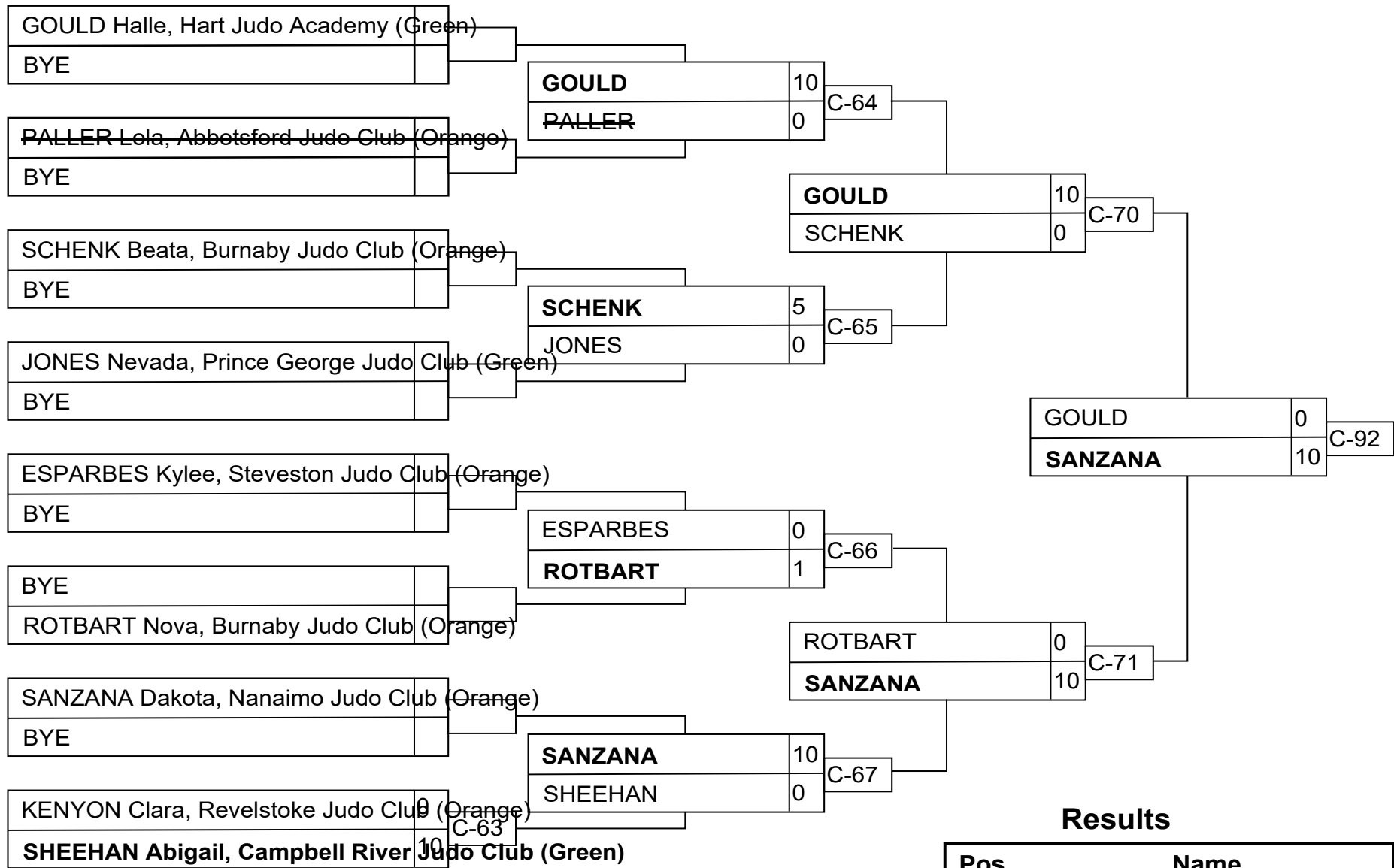

Results

Pos	Name
1	SANZANA Dakota, Nanaimo Judo Club
2	GOULD Halle, Hart Judo Academy (Gr
3	SCHENK Beata, Burnaby Judo Club (C
3	ROT BART Nova, Burnaby Judo Club (

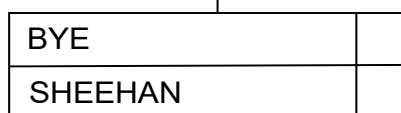
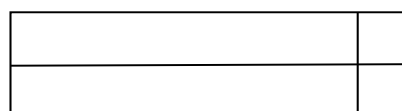

C-67

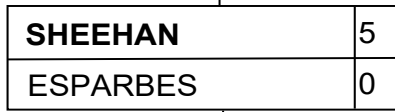
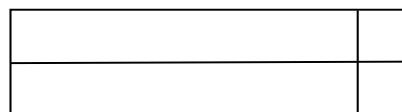

C-81

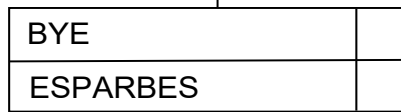

C-66

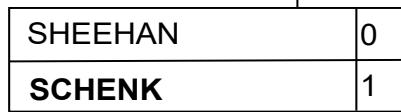

C-70

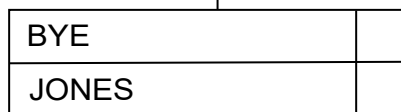
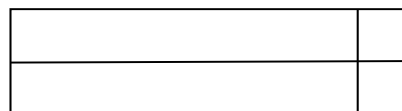

C-65

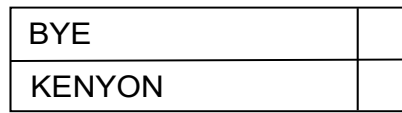

C-63

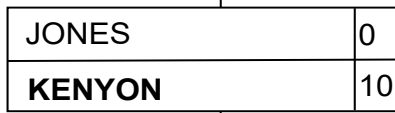

C-82

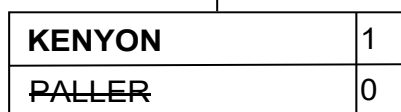

C-64



C-71

Competitors A

#	Name	Grade	Club	1	2	3	Wins	Pts	Pos
1	KATALINIC Sadie	Orange	Abbotsford Judo Club	XX		10	1	10	2
2	JONES Fallon	Green	Prince George Judo Club	10	XX	10	2	20	1
3	YAMAKAWA Jordyn	Orange	Kamloops Judo Club			XX	0	0	3

Matches A

Match	White	Blue	Result	Time	Code
1	KATALINIC Sadie	1 2 JONES Fallon	0 - 10	1:30	IPO
3	KATALINIC Sadie	1 3 YAMAKAWA Jordyn	10 - 0	2:49	IPO
5	JONES Fallon	2 3 YAMAKAWA Jordyn	10 - 0	0:29	IPO

Competitors B

#	Name	Grade	Club	4	5	6	Wins	Pts	Pos
4	MORISHO Nyota	Blue	Victoria Judo Club	XX	10	5	2	15	1
5	BIXBY Teigan	Orange	Vernon Judo Club		XX		0	0	3
6	LEE Zoe	Green	Westminster Judo Club		10	XX	1	10	2

Matches B

Match	White	Blue	Result	Time	Code
2	MORISHO Nyota	4 5 BIXBY Teigan	10 - 0	0:30	IPO
4	MORISHO Nyota	4 6 LEE Zoe	5 - 0	3:00	WAZ
6	BIXBY Teigan	5 6 LEE Zoe	0 - 10	0:51	IPO

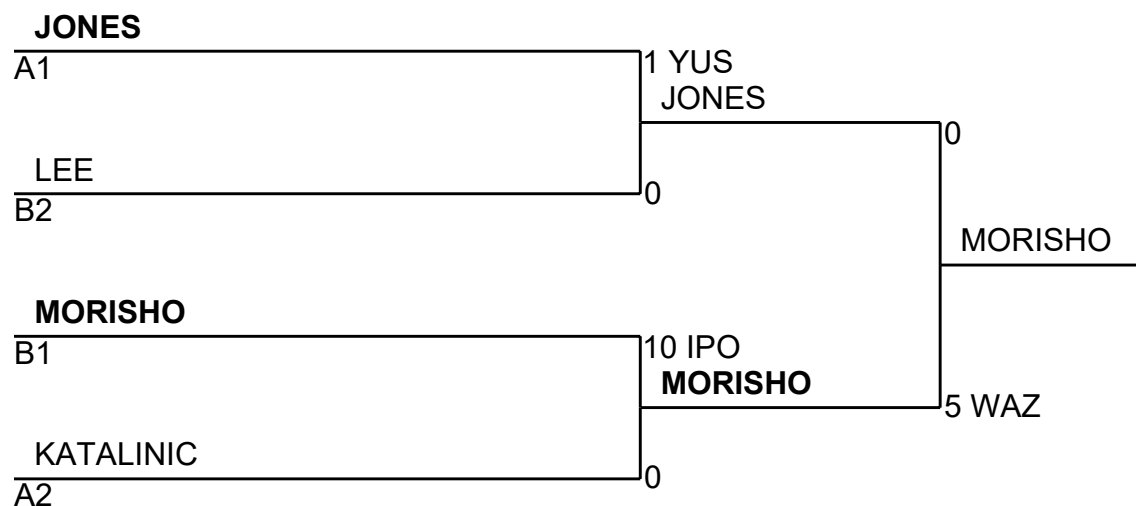

Results

Pos	Name
1	MORISHO Nyota, Victoria Judo Club
2	JONES Fallon, Prince George Judo Club
3	LEE Zoe, Westminster Judo Club
3	KATALINIC Sadie, Abbotsford Judo Club

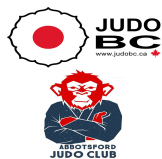

U14 Male -34Kg

Competitors A

#	Name	Grade	Club	1	2	3	4	Wins	Pts	Pos
1	WONG Jaime	Orange	Nakashima Dojo Judo Club	XX	1		10	2	11	2
2	FINKELSHTEIN Tom	Orange	Port Coquitlam Judo Club		XX			0	0	4
3	JOE Zackery	Orange	Burnaby Judo Club	10	10	XX	5	3	25	1
4	FRIZZELL Linus	Orange	Hart Judo Academy		1		XX	1	1	3

Matches A

Match	White	Blue	Result	Time	Code
B-57	WONG Jaime 1 2	FINKELSHTEIN Tom	1 - 0	3:00	YUS
B-58	JOE Zackery 3 4	FRIZZELL Linus	5 - 0	3:00	WAZ
B-63	WONG Jaime 1 3	JOE Zackery	0 - 10	3:00	IPO
B-64	FINKELSHTEIN Tom 2 4	FRIZZELL Linus	0 - 1	3:00	YUS
B-69	WONG Jaime 1 4	FRIZZELL Linus	10 - 0	0:42	IPO
B-70	FINKELSHTEIN Tom 2 3	JOE Zackery	0 - 10	1:48	IPO

Competitors B

#	Name	Grade	Club	5	6	7	Wins	Pts	Pos
5	CHOW James	Orange	Nakashima Dojo Judo Club	XX			0	0	3
6	BOULDING Arron	Orange	Nanaimo Judo Club	10	XX	5	2	15	1
7	GREENWOOD Joshua	Orange	Hart Judo Academy	5		XX	1	5	2

Matches B

Match	White	Blue	Result	Time	Code
B-59	CHOW James 5 6	BOULDING Arron	0 - 10	2:41	IPO
B-65	CHOW James 5 7	GREENWOOD Joshua	0 - 5	3:00	WAZ
B-71	BOULDING Arron 6 7	GREENWOOD Joshua	5 - 0	3:00	WAZ

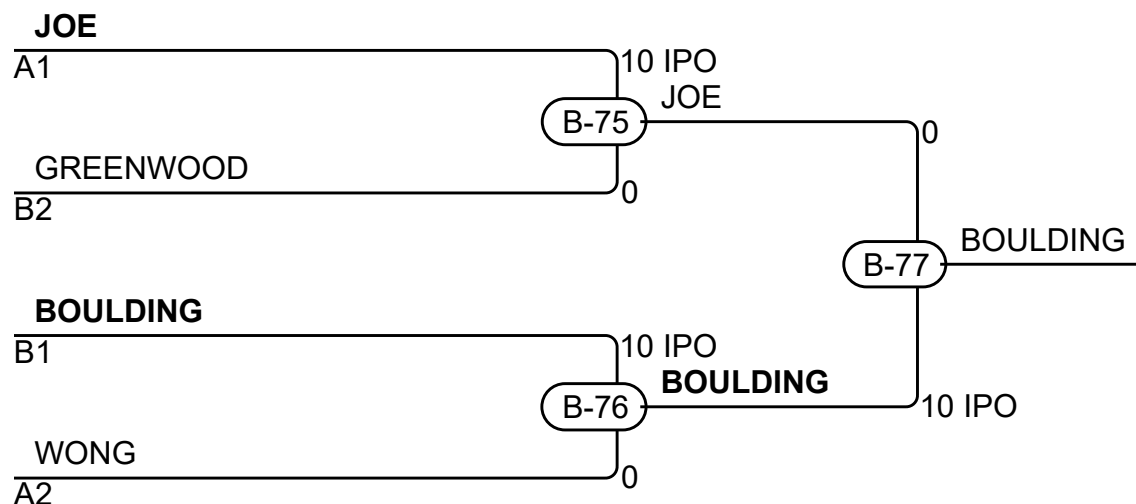

Results

Pos	Name
1	BOULDING Arron, Nanaimo Judo Club
2	JOE Zackery, Burnaby Judo Club
3	GREENWOOD Joshua, Hart Judo Academy
3	WONG Jaime, Nakashima Dojo Judo Club

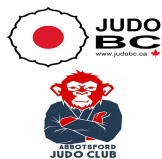

U14 Male -38Kg

Competitors A

#	Name	Grade	Club	1	2	3	Wins	Pts	Pos
1	SMITH Flynn	Orange	Mile Zero Judo Club	XX	10		1	10	2
2	FULTON Seth	Orange	Kamloops Judo Club		XX		0	0	3
3	HARRIS Carter	Green	Abbotsford Judo Club	10	10	XX	2	20	1

Matches A

Match	White	Blue	Result	Time	Code
C-68	SMITH Flynn	FULTON Seth	10 - 0	2:16	IPO
C-74	SMITH Flynn	HARRIS Carter	0 - 10	0:16	IPO
C-79	FULTON Seth	HARRIS Carter	0 - 10	0:13	IPO

Competitors B

#	Name	Grade	Club	4	5	6	Wins	Pts	Pos
4	VELONAS Peter	Green	Arashi Judo Club	XX	5	5	2	10	1
5	HILLMAN Corbin	Green	Prince George Judo Club		XX		0	0	3
6	COMLEY Kiyoshi	Orange	Vernon Judo Club		5	XX	1	5	2

Matches B

Match	White	Blue	Result	Time	Code
C-69	VELONAS Peter	HILLMAN Corbin	5 - 0	3:00	WAZ
C-75	VELONAS Peter	COMLEY Kiyoshi	5 - 0	3:00	WAZ
C-80	HILLMAN Corbin	COMLEY Kiyoshi	0 - 5	3:00	WAZ

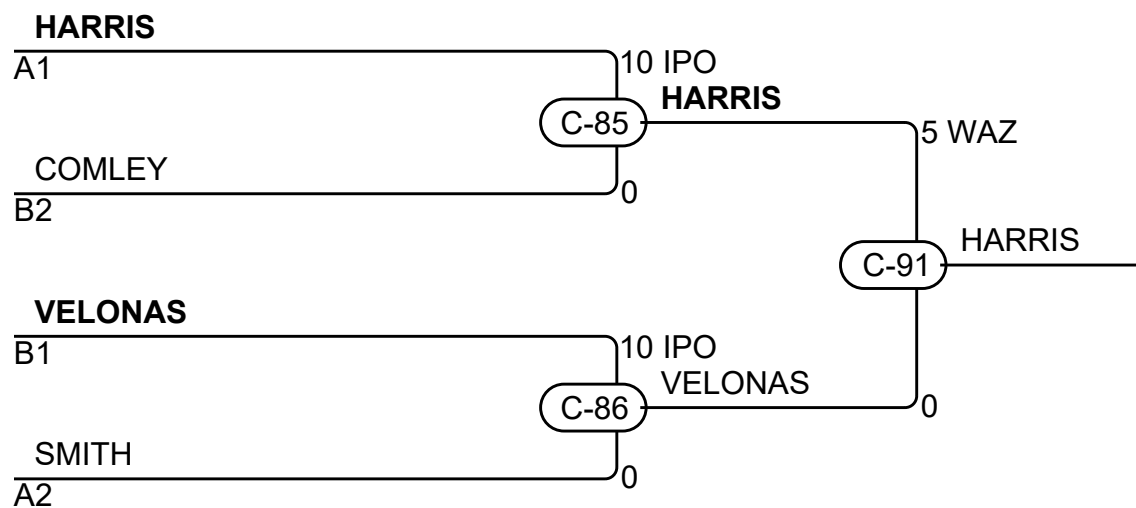

Results

Pos	Name
1	HARRIS Carter, Abbotsford Judo Club
2	VELONAS Peter, Arashi Judo Club
3	COMLEY Kiyoshi, Vernon Judo Club
3	SMITH Flynn, Mile Zero Judo Club

Competitors A

#	Name	Grade	Club	1	2	3	Wins	Pts	Pos
1	LEROUX Reece	Orange	Abbotsford Judo Club	XX	5		1	5	2
2	GILL Gavann	Orange	Steveston Judo Club		XX		0	0	3
3	OKANO Aaron	Green	Aberdeen Judo Academy	10	5	XX	2	15	1

Matches A

Match	White	Blue	Result	Time	Code
C-72	LEROUX Reece 1 2	GILL Gavann	5 - 0	3:00	WAZ
C-77	LEROUX Reece 1 3	OKANO Aaron	0 - 10	0:22	IPO
C-83	GILL Gavann 2 3	OKANO Aaron	0 - 5	3:00	WAZ

Competitors B

#	Name	Grade	Club	4	5	6	Wins	Pts	Pos
4	RAWLINGS Matteo	Orange	Aberdeen Judo Academy	XX			0	0	3
5	HANKS Graeme	Green	Aberdeen Judo Academy	10	XX		1	10	2
6	GILL Isaiah	Green	Abbotsford Judo Club	10	5	XX	2	15	1

Matches B

Match	White	Blue	Result	Time	Code
C-73	RAWLINGS Matteo 4 5	HANKS Graeme	0 - 10	2:25	IPO
C-78	RAWLINGS Matteo 4 6	GILL Isaiah	0 - 10	2:31	IPO
C-84	HANKS Graeme 5 6	GILL Isaiah	0 - 5	3:00	WAZ

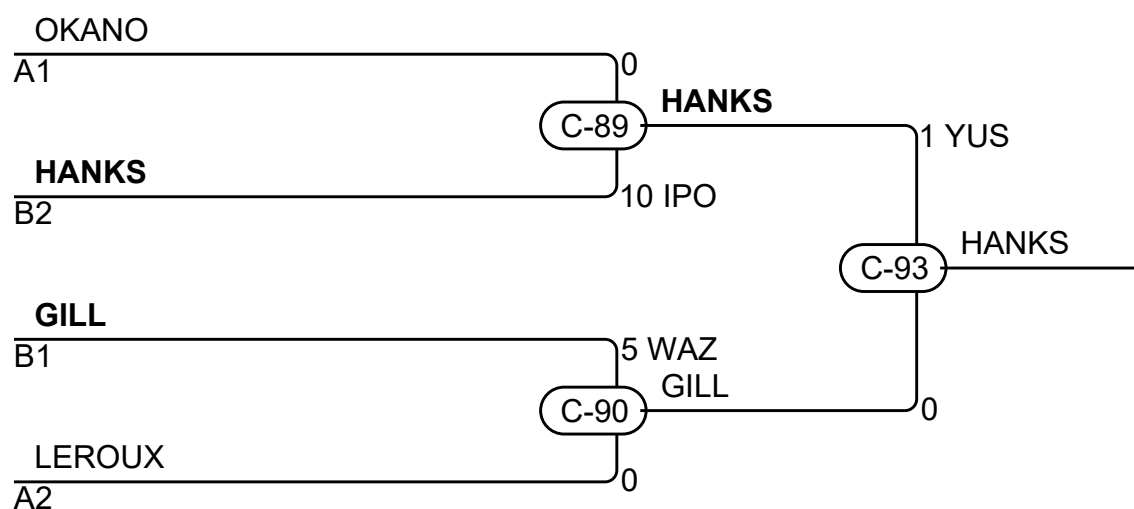

Results

Pos	Name
1	HANKS Graeme, Aberdeen Judo Academy
2	GILL Isaiah, Abbotsford Judo Club
3	OKANO Aaron, Aberdeen Judo Academy
3	LEROUX Reece, Abbotsford Judo Club

Competitors

#	Name	Grade	Club	1	2	3	4	Wins	Pts	Pos
1	SIMPSON Logan	Green	Abbotsford Judo Club	XX				0	0	4
2	GILL Elijah	Green	Abbotsford Judo Club	5	XX	1	10	3	16	1
3	CAJIGAS Ethan	Orange	Steveston Judo Club	10		XX	10	2	20	2
4	SWANN Nelson	Orange	Kokoro Judo Association	10			XX	1	10	3

Matches

Match	White		Blue		Result	Time	Code
B-60	SIMPSON Logan	1	2	GILL Elijah	0 - 5	3:00	WAZ
B-61	CAJIGAS Ethan	3	4	SWANN Nelson	10 - 0	1:18	IPO
B-66	SIMPSON Logan	1	3	CAJIGAS Ethan	0 - 10	2:59	IPO
B-67	GILL Elijah	2	4	SWANN Nelson	10 - 0	1:11	IPO
B-72	SIMPSON Logan	1	4	SWANN Nelson	0 - 10	0:01	KIK
B-73	GILL Elijah	2	3	CAJIGAS Ethan	1 - 0	3:00	YUS

Results

Pos	Name
1	GILL Elijah, Abbotsford Judo Club
2	CAJIGAS Ethan, Steveston Judo Club
3	SWANN Nelson, Kokoro Judo Association

Competitors

#	Name	Grade	Club	1	2	3	4	5	Wins	Pts	Pos
1	NEWCOMEN Finn	Orange	Kamloops Judo Club	XX		10			1	10	4
2	GOLOVYAK Nikolai	Green	Nakashima Dojo Judo Club	5	XX	10			2	15	3
3	DUMITRACHE Andrei	Orange	Abbotsford Judo Club			XX			0	0	5
4	SHAKIMOV Diar	Green	Burnaby Judo Club	10	10	10	XX	1	4	31	1
5	TARITA Demitru	Green	Westminster Judo Club	10	10	10		XX	3	30	2

Matches

Match	White	Blue	Result	Time	Code	
1	SHAKIMOV Diar	TARITA Demitru	4 - 5	1 - 0	0:00	YUS
2	NEWCOMEN Finn	GOLOVYAK Nikolai	1 - 2	0 - 5	1:08	WAZ
3	DUMITRACHE Andrei	SHAKIMOV Diar	3 - 4	0 - 10	1:17	IPO
4	NEWCOMEN Finn	TARITA Demitru	1 - 5	0 - 10	0:25	IPO
5	GOLOVYAK Nikolai	DUMITRACHE Andrei	2 - 3	10 - 0	1:58	IPO
6	NEWCOMEN Finn	SHAKIMOV Diar	1 - 4	0 - 10	0:17	IPO
7	DUMITRACHE Andrei	TARITA Demitru	3 - 5	0 - 10	3:00	IPO
8	GOLOVYAK Nikolai	SHAKIMOV Diar	2 - 4	0 - 10	0:18	IPO
9	NEWCOMEN Finn	DUMITRACHE Andrei	1 - 3	10 - 0	2:59	IPO
10	GOLOVYAK Nikolai	TARITA Demitru	2 - 5	0 - 10	2:23	IPO

Results

Pos	Name
1	SHAKIMOV Diar, Burnaby Judo Club
2	TARITA Demitru, Westminster Judo Club
3	GOLOVYAK Nikolai, Nakashima Dojo Judo Club
4	NEWCOMEN Finn, Kamloops Judo Club

Competitors A

#	Name	Grade	Club	1	2	3	Wins	Pts	Pos
1	GUEZILLE Suliac	Green	Police Judo Junior	XX	10	10	2	20	1
2	MACDONALD Bostyn	Green	Nanaimo Judo Club		XX		0	0	3
3	MOLSKI Matthew	Orange	White Rock Judo Club		10	XX	1	10	2

Matches A

Match	White	Blue	Result	Time	Code
1	GUEZILLE Suliac	1 2 MACDONALD Bostyn	10 - 0	0:29	IPO
3	GUEZILLE Suliac	1 3 MOLSKI Matthew	10 - 0	3:00	IPO
5	MACDONALD Bostyn	2 3 MOLSKI Matthew	0 - 10	1:29	IPO

Competitors B

#	Name	Grade	Club	4	5	6	Wins	Pts	Pos
4	VAN ZYL Martinus	Green	Hart Judo Academy	XX			0	0	3
5	TAMAYOSE Ryu	Orange	Steveston Judo Club	10	XX		1	10	2
6	GAANAN Raphael	Green	Burnaby Judo Club	10	10	XX	2	20	1

Matches B

Match	White	Blue	Result	Time	Code
2	VAN ZYL Martinus	4 5 TAMAYOSE Ryu	0 - 10	0:38	IPO
4	VAN ZYL Martinus	4 6 GAANAN Raphael	0 - 10	0:07	IPO
6	TAMAYOSE Ryu	5 6 GAANAN Raphael	0 - 10	0:07	IPO

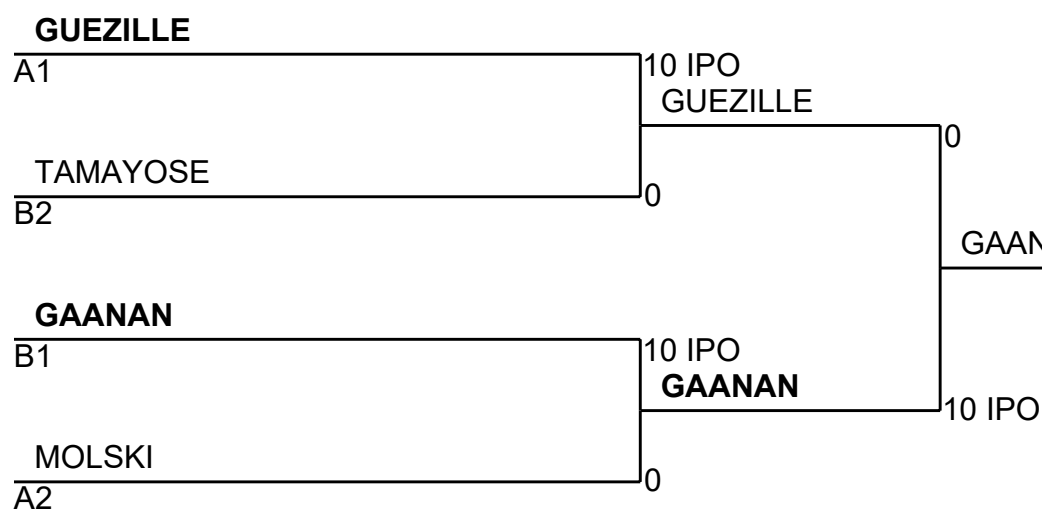

Results

Pos	Name
1	GAANAN Raphael, Burnaby Judo Club
2	GUEZILLE Suliac, Police Judo Junior
3	TAMAYOSE Ryu, Steveston Judo Club
3	MOLSKI Matthew, White Rock Judo Club

Competitors A

#	Name	Grade	Club	1	2	3	Wins	Pts	Pos
1	SHEEHAN Abigail	Green	Campbell River Judo Club	XX			0	0	3
2	BONDT Nadine	Green	Vernon Judo Club	5	XX		1	5	2
3	SANZANA Dakota	Orange	Nanaimo Judo Club	5	10	XX	2	15	1

Matches A

Match	White	Blue	Result	Time	Code
D-23	SHEEHAN Abigail 1 2	BONDT Nadine	0 - 5	3:00	WAZ
D-32	SHEEHAN Abigail 1 3	SANZANA Dakota	0 - 5	3:00	WAZ
D-41	BONDT Nadine 2 3	SANZANA Dakota	0 - 10	1:22	IPO

Competitors B

#	Name	Grade	Club	4	5	6	Wins	Pts	Pos
4	DANILKOV Ekaterina	Orange	Burnaby Judo Club	XX	5		1	5	2
5	SHEARER Lola	Orange	Steveston Judo Club		XX	5	1	5	3
6	GOULD Halle	Green	Hart Judo Academy	10		XX	1	10	1

Matches B

Match	White	Blue	Result	Time	Code
D-24	DANILKOV Ekaterina 4 5	SHEARER Lola	5 - 0	3:00	WAZ
D-33	DANILKOV Ekaterina 4 6	GOULD Halle	0 - 10	0:38	IPO
D-42	SHEARER Lola 5 6	GOULD Halle	5 - 0	3:00	WAZ

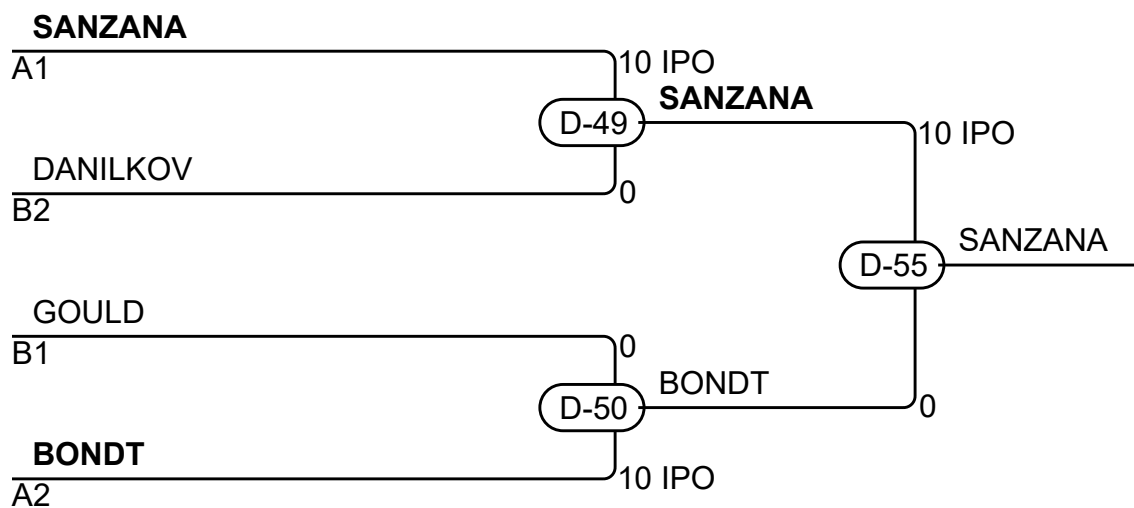

Results

Pos	Name
1	SANZANA Dakota, Nanaimo Judo Club
2	BONDT Nadine, Vernon Judo Club
3	DANILKOV Ekaterina, Burnaby Judo Club
3	GOULD Halle, Hart Judo Academy



U16 Female -48Kg

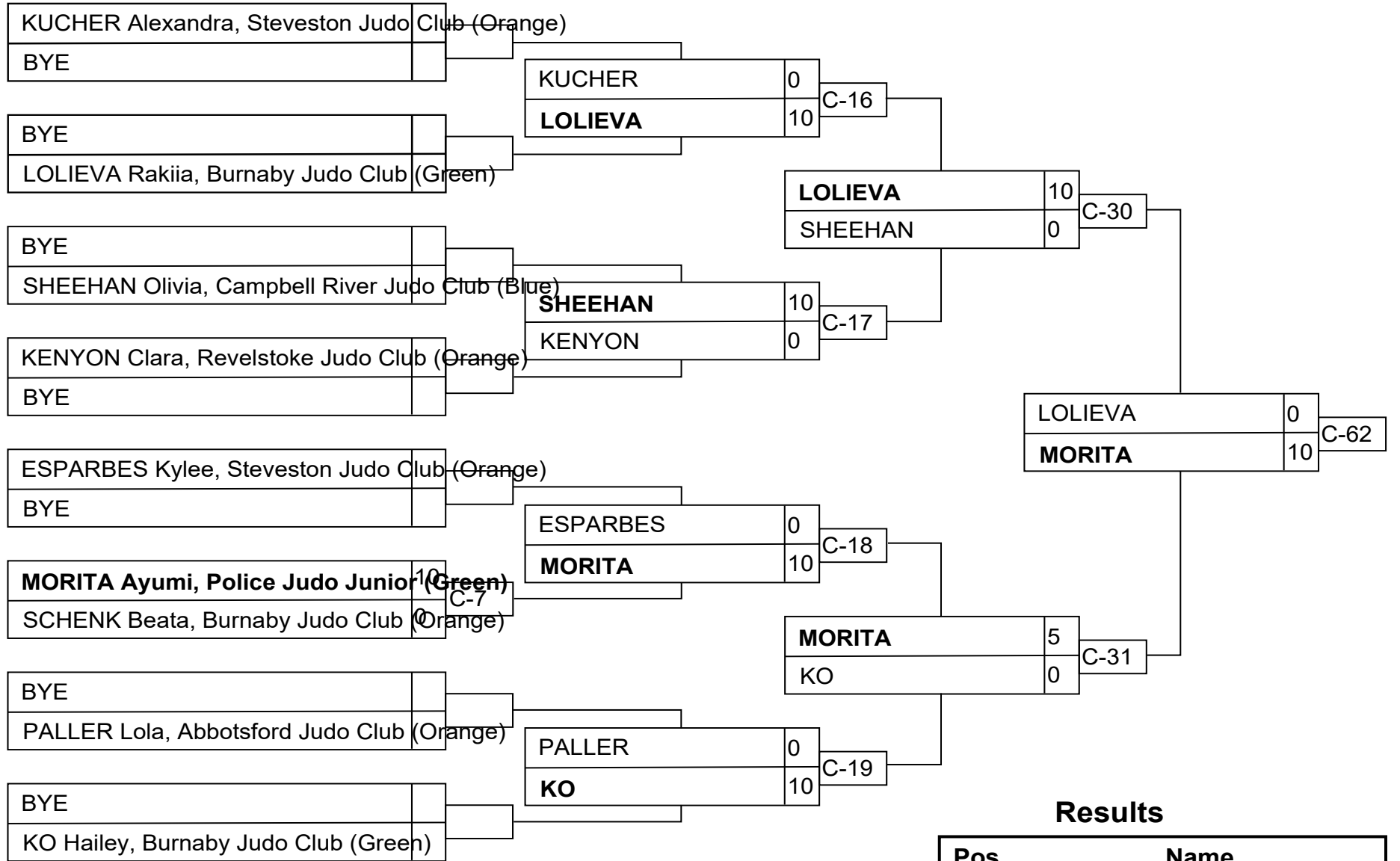

Results

Pos	Name
1	MORITA Ayumi, Police Judo Junior (Green)
2	LOLIEVA Rakiia, Burnaby Judo Club (Green)
3	SHEEHAN Olivia, Campbell River Judo Club (Blue)
3	KO Hailey, Burnaby Judo Club (Green)

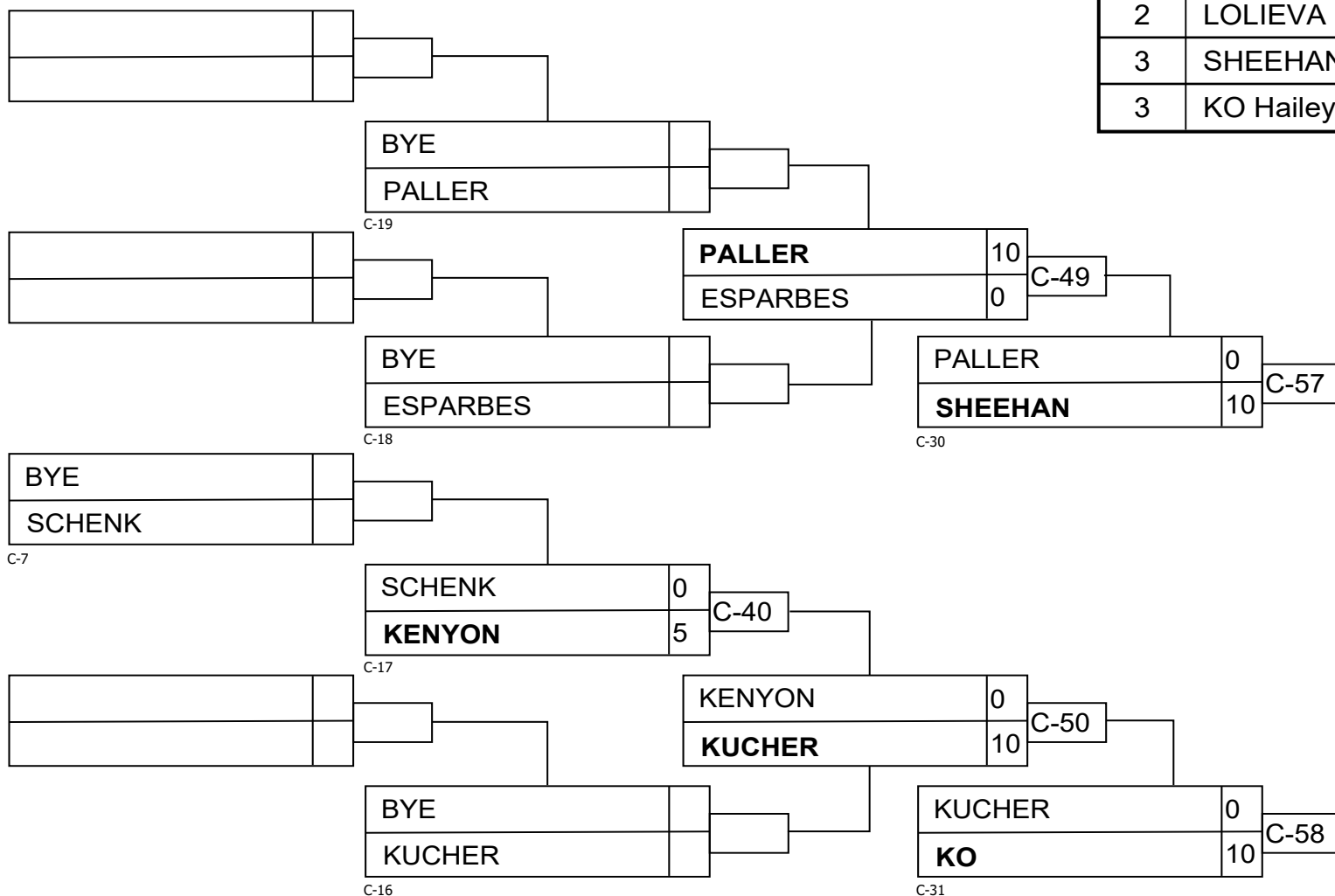

Competitors A

#	Name	Grade	Club	1	2	3	Wins	Pts	Pos
1	KATALINIC Sadie	Green	Abbotsford Judo Club	XX			0	0	3
2	GREENE Isabella	Green	Nanaimo Judo Club	10	XX	10	2	20	1
3	LACROIX Keisha	Orange	Kamloops Judo Club	10		XX	1	10	2

Matches A

Match	White	Blue	Result	Time	Code
C-22	KATALINIC Sadie 1 2	GREENE Isabella	0 - 10	0:30	IPO
C-32	KATALINIC Sadie 1 3	LACROIX Keisha	0 - 10	1:18	IPO
C-41	GREENE Isabella 2 3	LACROIX Keisha	10 - 0	0:24	IPO

Competitors B

#	Name	Grade	Club	4	5	6	Wins	Pts	Pos
4	AL-ASHOOR Jasmine	Orange	Arashi Judo Club	XX	10	10	2	20	1
5	MARSTON Marlin	Green	Nanaimo Judo Club		XX	10	1	10	2
6	STEVENSON Apria	Orange	Kokushikai Judo			XX	0	0	3

Matches B

Match	White	Blue	Result	Time	Code
C-23	AL-ASHOOR Jasmine 4 5	MARSTON Marlin	10 - 0	4:56	GSI
C-33	AL-ASHOOR Jasmine 4 6	STEVENSON Apria	10 - 0	0:10	IPO
C-42	MARSTON Marlin 5 6	STEVENSON Apria	10 - 0	1:19	IPO

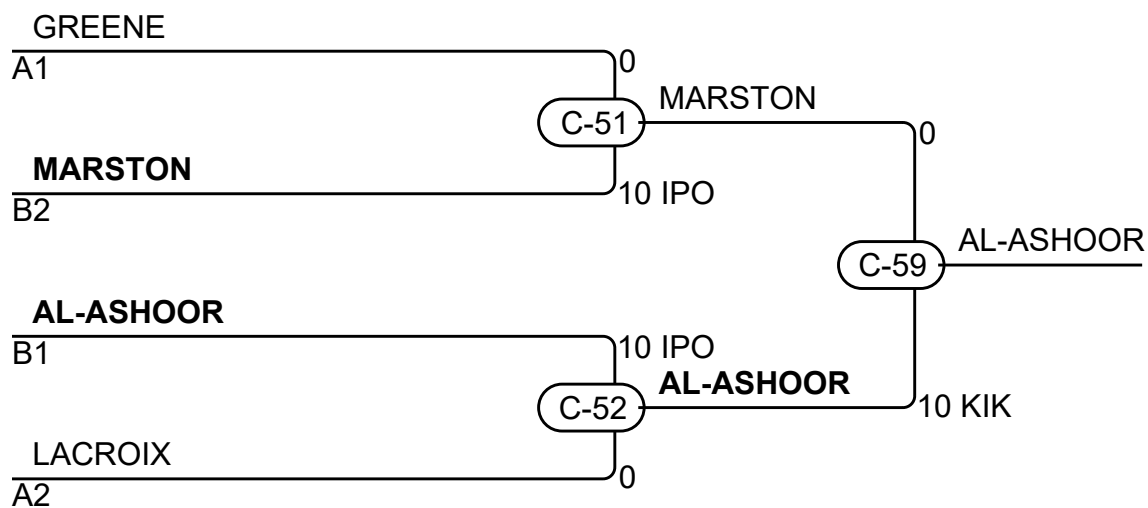

Results

Pos	Name
1	AL-ASHOOR Jasmine, Arashi Judo Club
2	MARSTON Marlin, Nanaimo Judo Club
3	GREENE Isabella, Nanaimo Judo Club
3	LACROIX Keisha, Kamloops Judo Club



U16 Female -57Kg

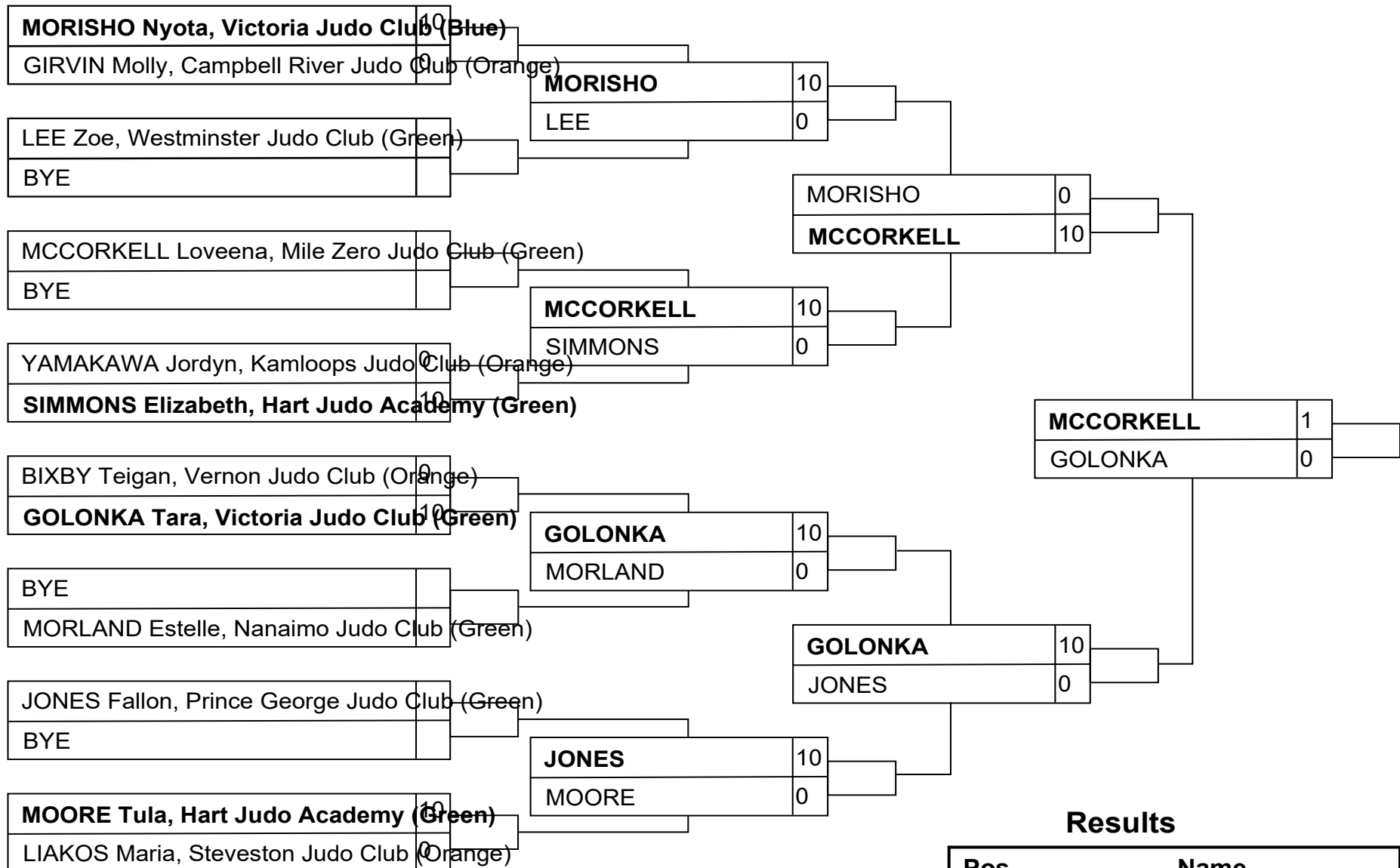

Results

Pos	Name
1	MCCORKELL Loveena, Mile Zero Judo Club (Green)
2	GOLONKA Tara, Victoria Judo Club (Green)
3	MORISHO Nyota, Victoria Judo Club (Blue)
3	JONES Fallon, Prince George Judo Club (Green)

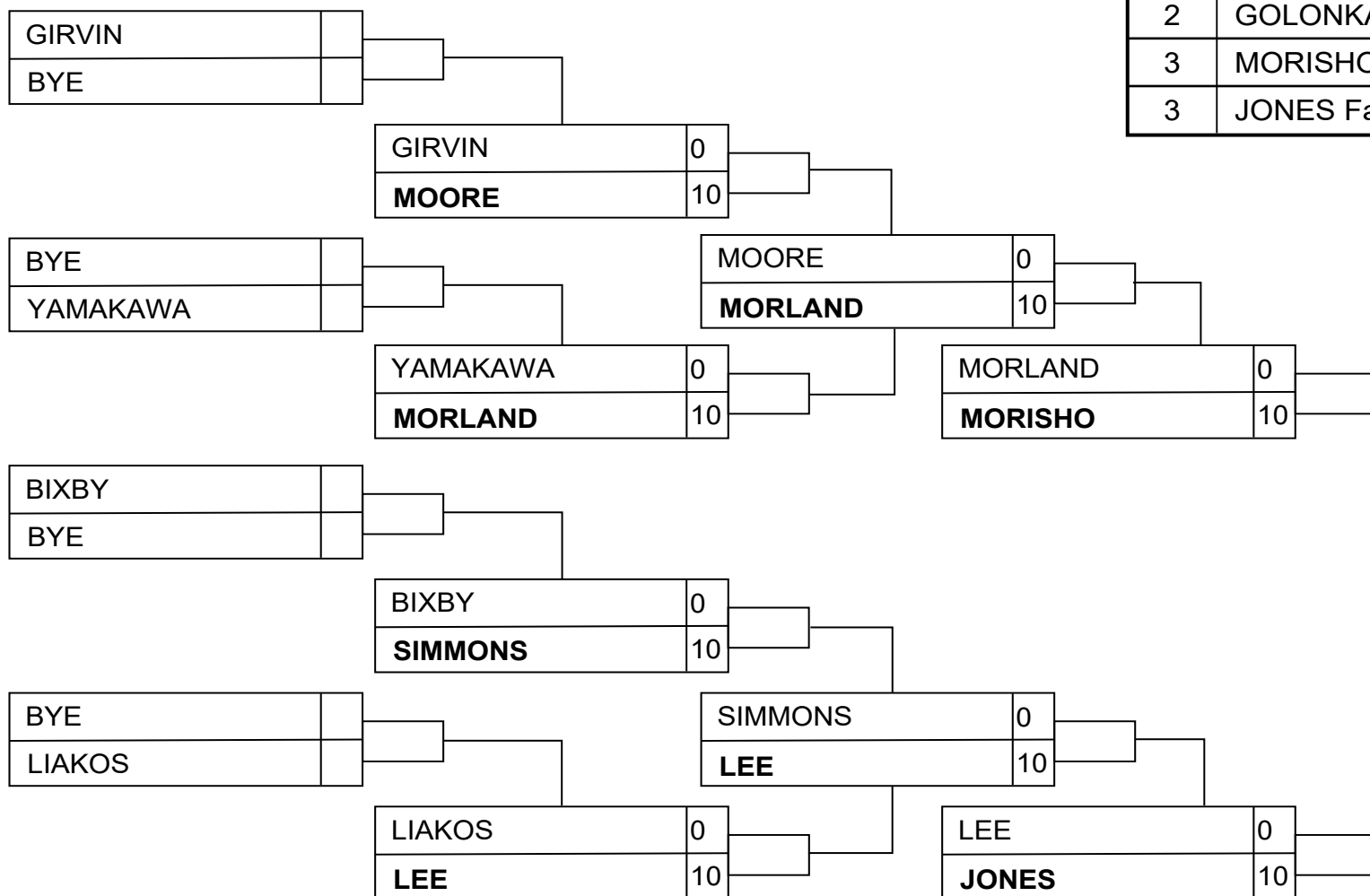

Competitors

#	Name	Grade	Club	1	2	3	4	Wins	Pts	Pos
1	LUND Tianna	Green	Campbell River Judo Club	XX	10	5		2	15	2
2	LOWENSTEIN Jade	Green	Penticton Judo Club		XX	5		1	5	3
3	AGASSIZ Kaylin	Green	Abbotsford Judo Club			XX		0	0	4
4	EDGSON Sydney	Blue	Prince George Judo Club	10	5	10	XX	3	25	1

Matches

Match	White		Blue		Result	Time	Code
B-10	LUND Tianna	1	2	LOWENSTEIN Jade	10 - 0	0:36	IPO
B-11	AGASSIZ Kaylin	3	4	EDGSON Sydney	0 - 10	2:40	IPO
B-23	LUND Tianna	1	3	AGASSIZ Kaylin	5 - 0	3:49	GSW
B-24	LOWENSTEIN Jade	2	4	EDGSON Sydney	0 - 5	3:00	WAZ
B-35	LUND Tianna	1	4	EDGSON Sydney	0 - 10	1:45	IPO
B-36	LOWENSTEIN Jade	2	3	AGASSIZ Kaylin	5 - 0	3:46	GSW

Results

Pos	Name
1	EDGSON Sydney, Prince George Judo Club
2	LUND Tianna, Campbell River Judo Club
3	LOWENSTEIN Jade, Penticton Judo Club

Competitors A

#	Name	Grade	Club	1	2	3	4	Wins	Pts	Pos
1	WEBB Dakota	Green	Kokushikai Judo	XX				0	0	4
2	CALDER Mira	Blue	Kokushikai Judo	10	XX	10	10	3	30	1
3	BURGESS Willow	Blue	Abbotsford Judo Club	10		XX	5	2	15	2
4	JACOBS Yana	Green	Campbell River Judo Club	5			XX	1	5	3

Matches A

Match	White	Blue	Result	Time	Code
B-18	WEBB Dakota 1 2	CALDER Mira	0 - 10	1:53	IPO
B-19	BURGESS Willow 3 4	JACOBS Yana	5 - 0	3:00	WAZ
B-30	WEBB Dakota 1 3	BURGESS Willow	0 - 10	0:53	IPO
B-31	CALDER Mira 2 4	JACOBS Yana	10 - 0	1:13	IPO
B-43	WEBB Dakota 1 4	JACOBS Yana	0 - 5	6:53	GSW
B-44	CALDER Mira 2 3	BURGESS Willow	10 - 0	2:56	IPO

Competitors B

#	Name	Grade	Club	5	6	7	Wins	Pts	Pos
5	KUCHER Emma	Green	Steveston Judo Club	XX	10	10	2	20	1
6	LINDSAY Emily	Orange	Kamloops Judo Club		XX	10	1	10	2
7	SCHOLTZ Amelia	Orange	Kokushikai Judo			XX	0	0	3

Matches B

Match	White	Blue	Result	Time	Code
B-20	KUCHER Emma 5 6	LINDSAY Emily	10 - 0	1:27	IPO
B-32	KUCHER Emma 5 7	SCHOLTZ Amelia	10 - 0	1:05	IPO
B-45	LINDSAY Emily 6 7	SCHOLTZ Amelia	10 - 0	1:06	IPO

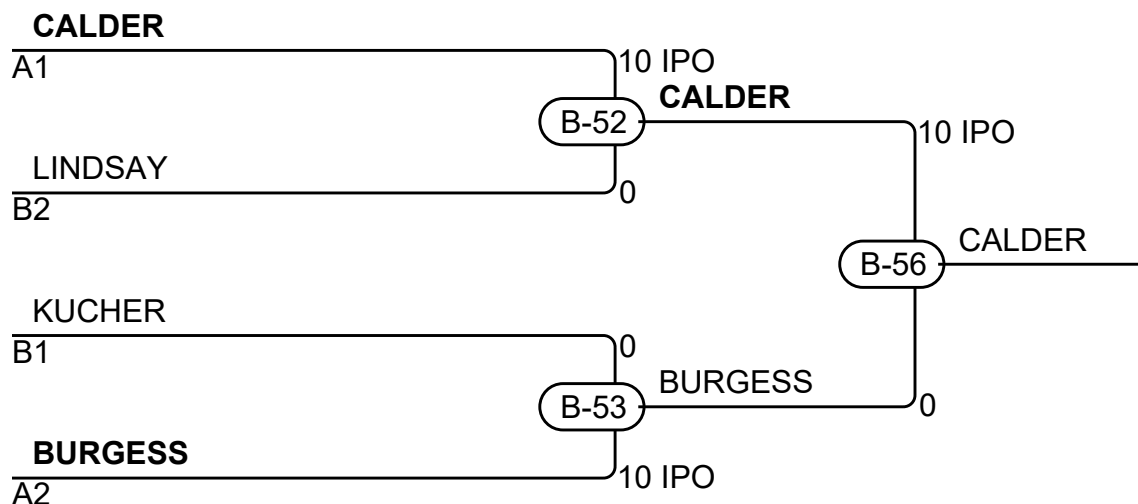

Results

Pos	Name
1	CALDER Mira, Kokushikai Judo
2	BURGESS Willow, Abbotsford Judo Club
3	LINDSAY Emily, Kamloops Judo Club
3	KUCHER Emma, Steveston Judo Club



U16 Male -38Kg

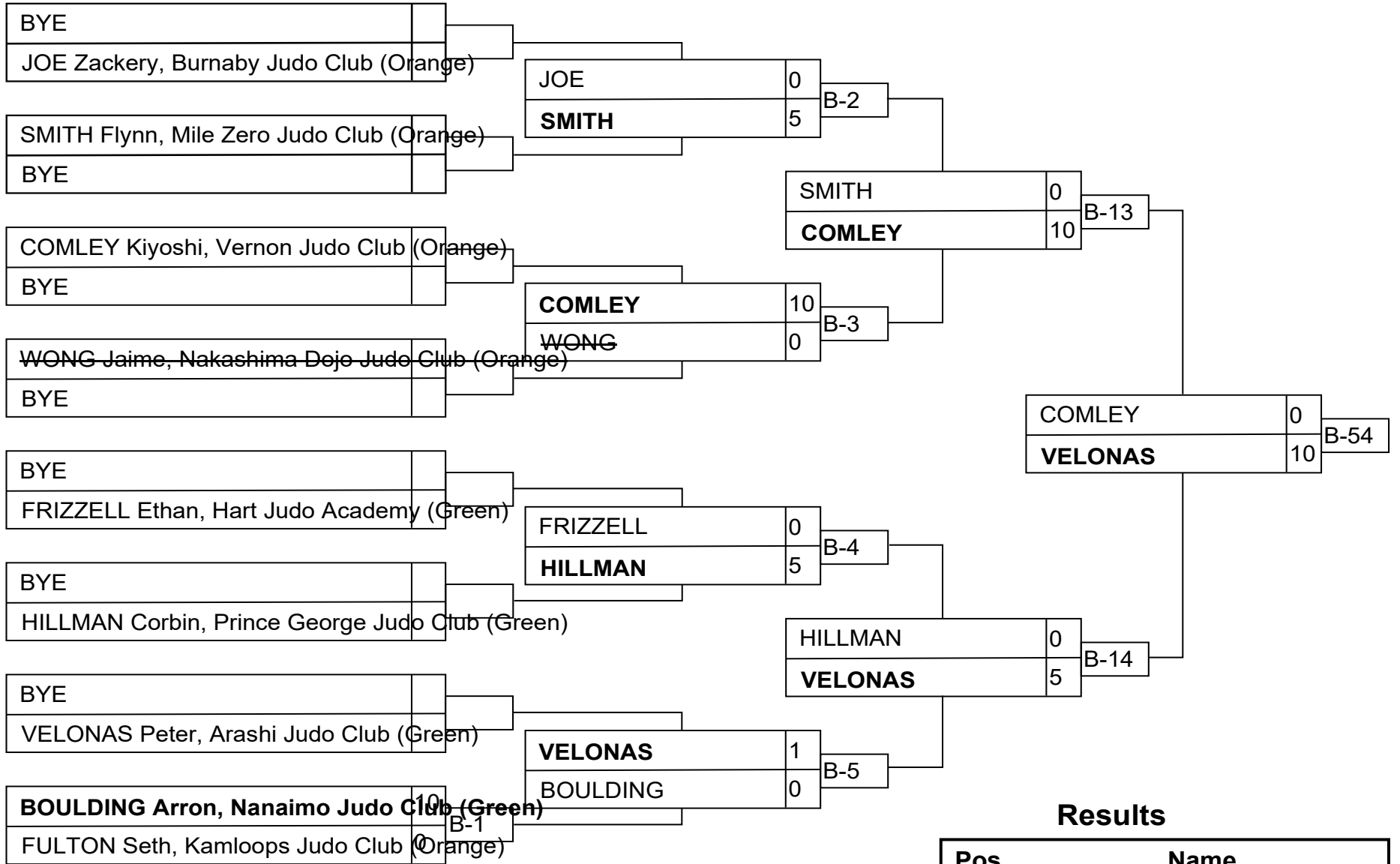

Results

Pos	Name
1	VELONAS Peter, Arashi Judo Club (Green)
2	COMLEY Kiyoshi, Vernon Judo Club (Orange)
3	BOULDING Arron, Nanaimo Judo Club (Green)
3	JOE Zackery, Burnaby Judo Club (Orange)

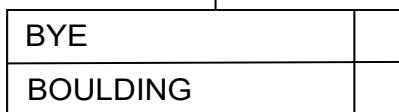
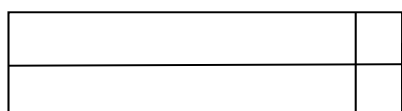

B-5

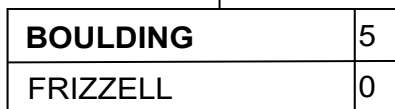
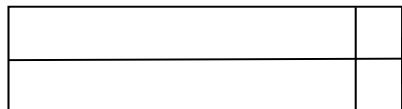

B-38

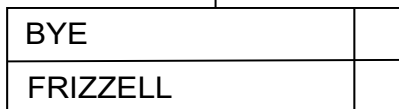

B-4

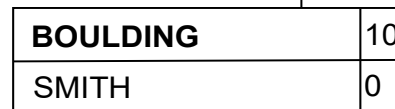

B-13

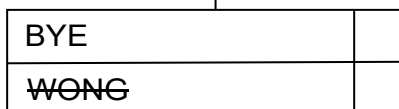
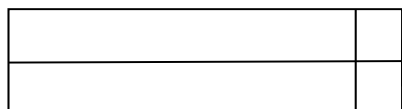

B-3

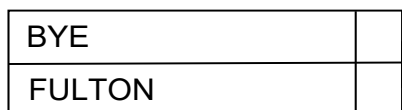

B-1

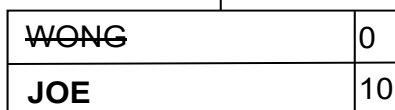

B-39

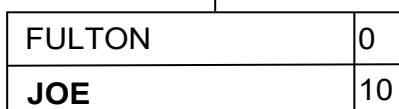

B-2

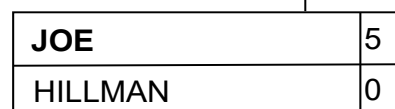

B-14



U16 Male -42Kg

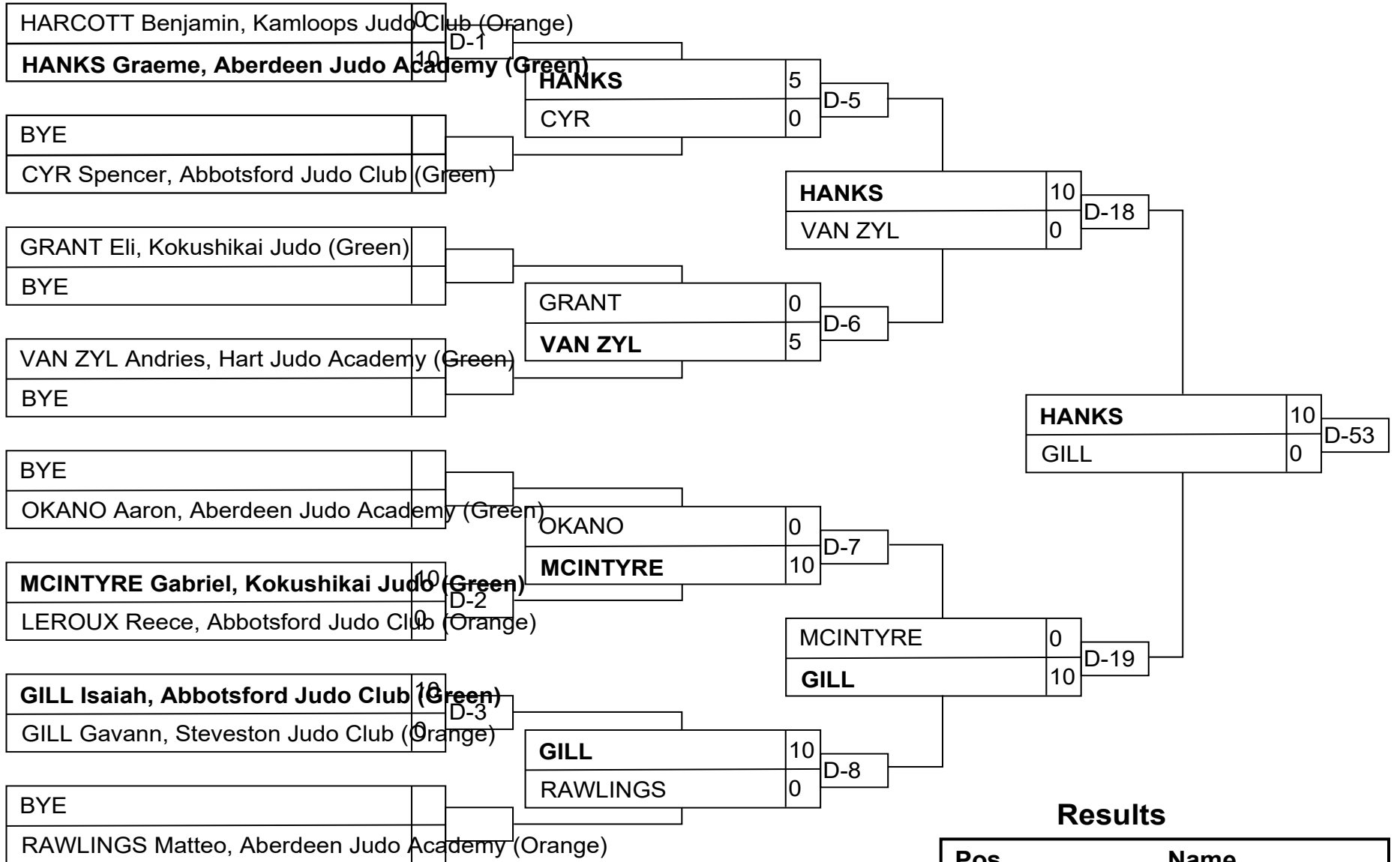

Results

Pos	Name
1	HANKS Graeme, Aberdeen Judo Academy (Green)
2	GILL Isaiah, Abbotsford Judo Club (Green)
3	OKANO Aaron, Aberdeen Judo Academy (Green)
3	GRANT Eli, Kokushikai Judo (Green)

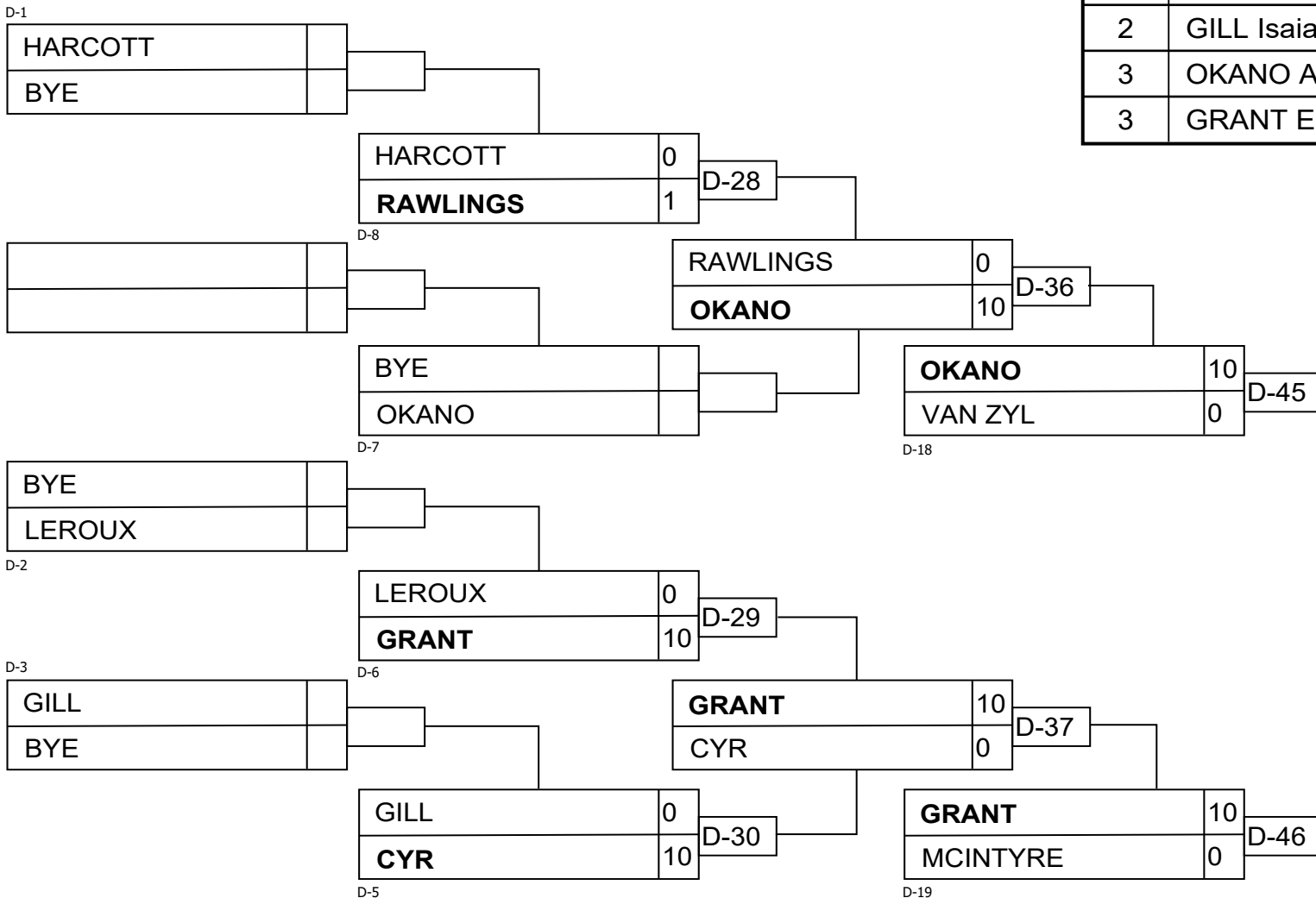

U16 Male -46Kg

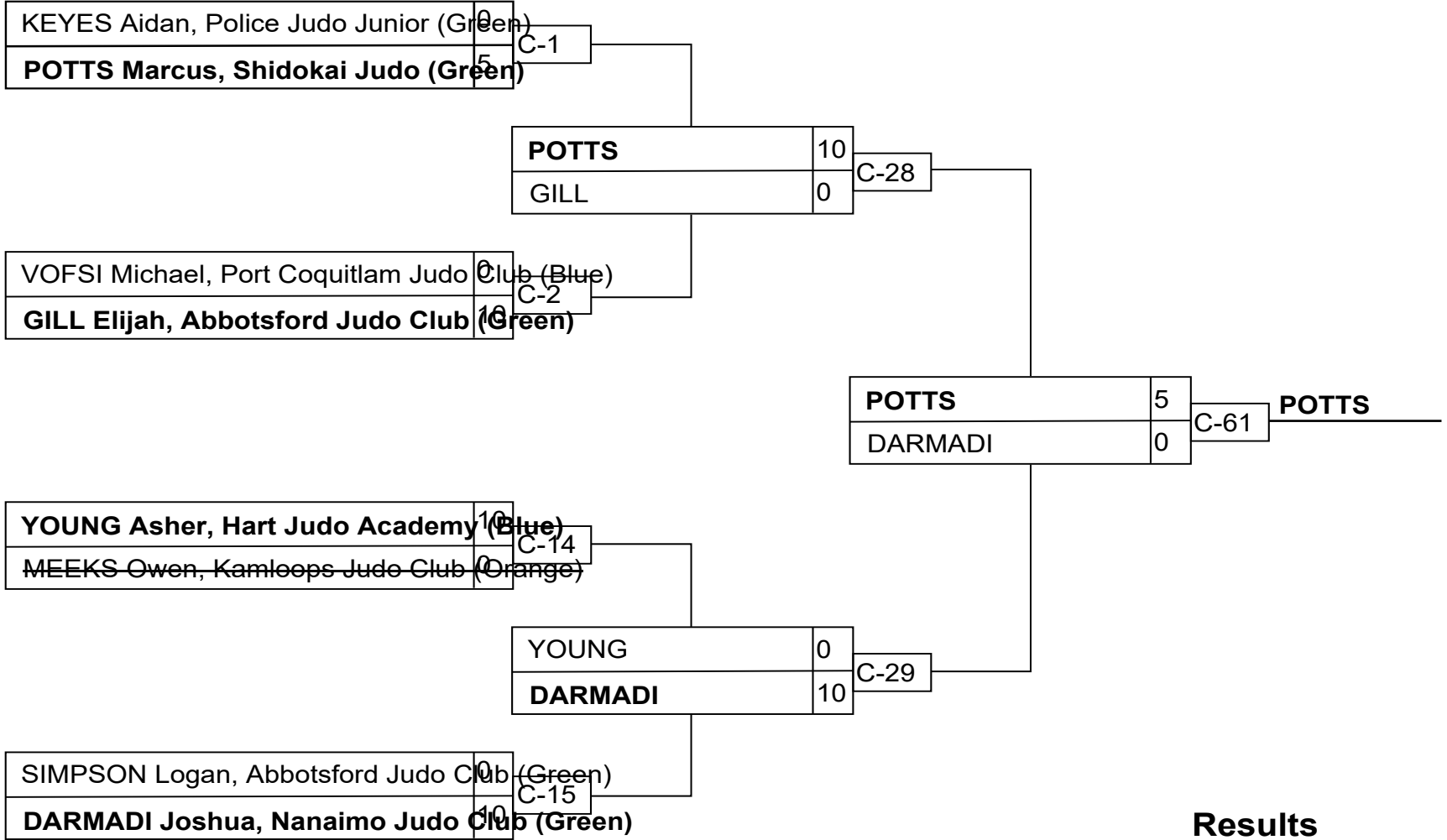

Results

Pos	Name
1	POTTS Marcus, Shidokai Judo (Green)
2	DARMADI Joshua, Nanaimo Judo Club (Green)
3	GILL Elijah, Abbotsford Judo Club (Green)
3	YOUNG Asher, Hart Judo Academy (Blue)

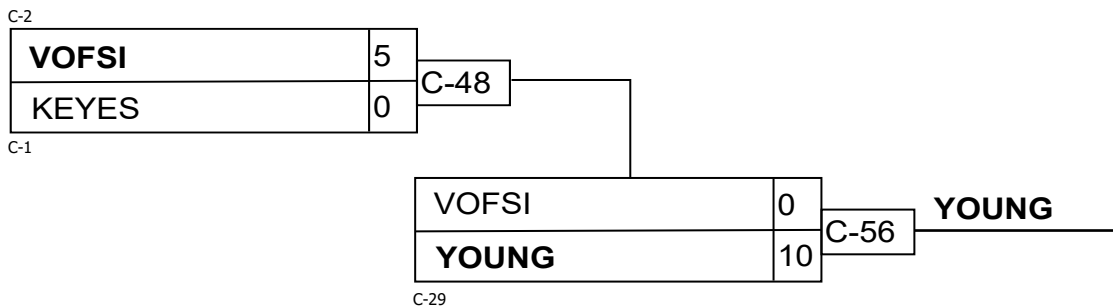
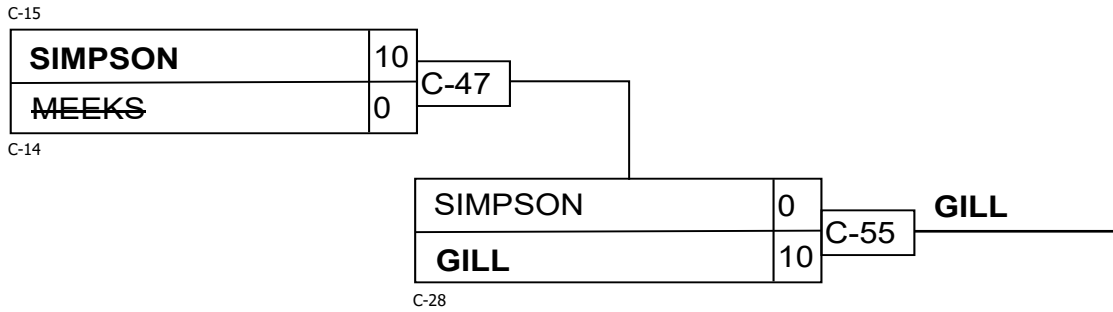

U16 Male -50Kg

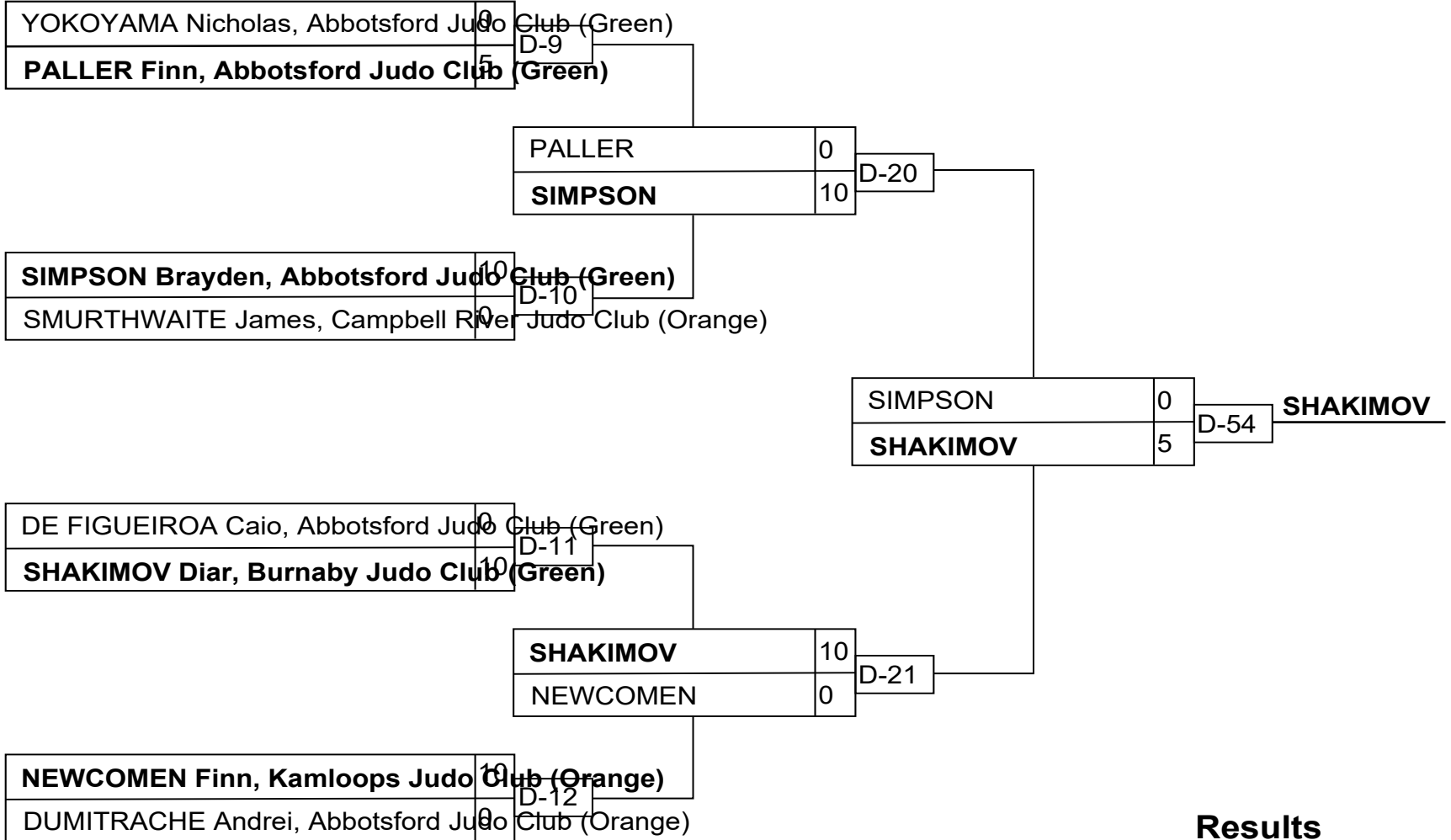

Results

Pos	Name
1	SHAKIMOV Diar, Burnaby Judo Club
2	SIMPSON Brayden, Abbotsford Judo Club
3	DE FIGUEIROA Caio, Abbotsford Judo Club
3	NEWCOMEN Finn, Kamloops Judo Club

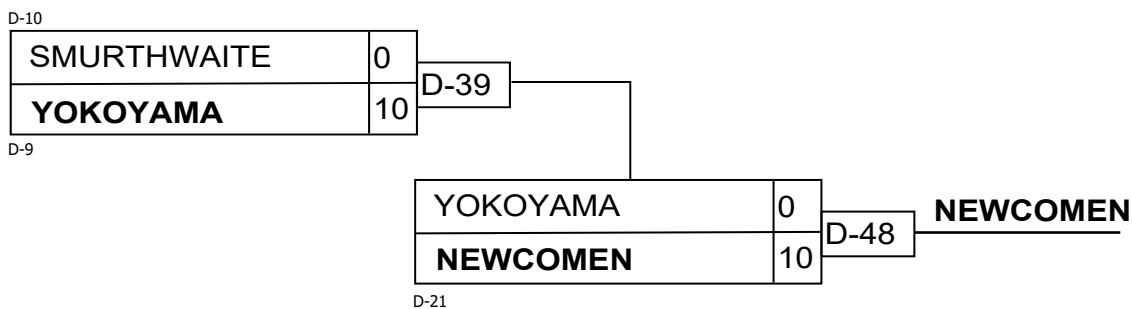
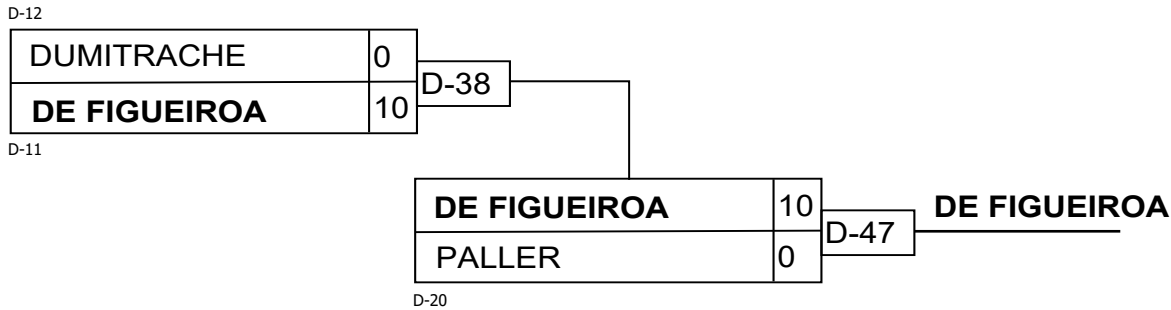



U16 Male -55Kg

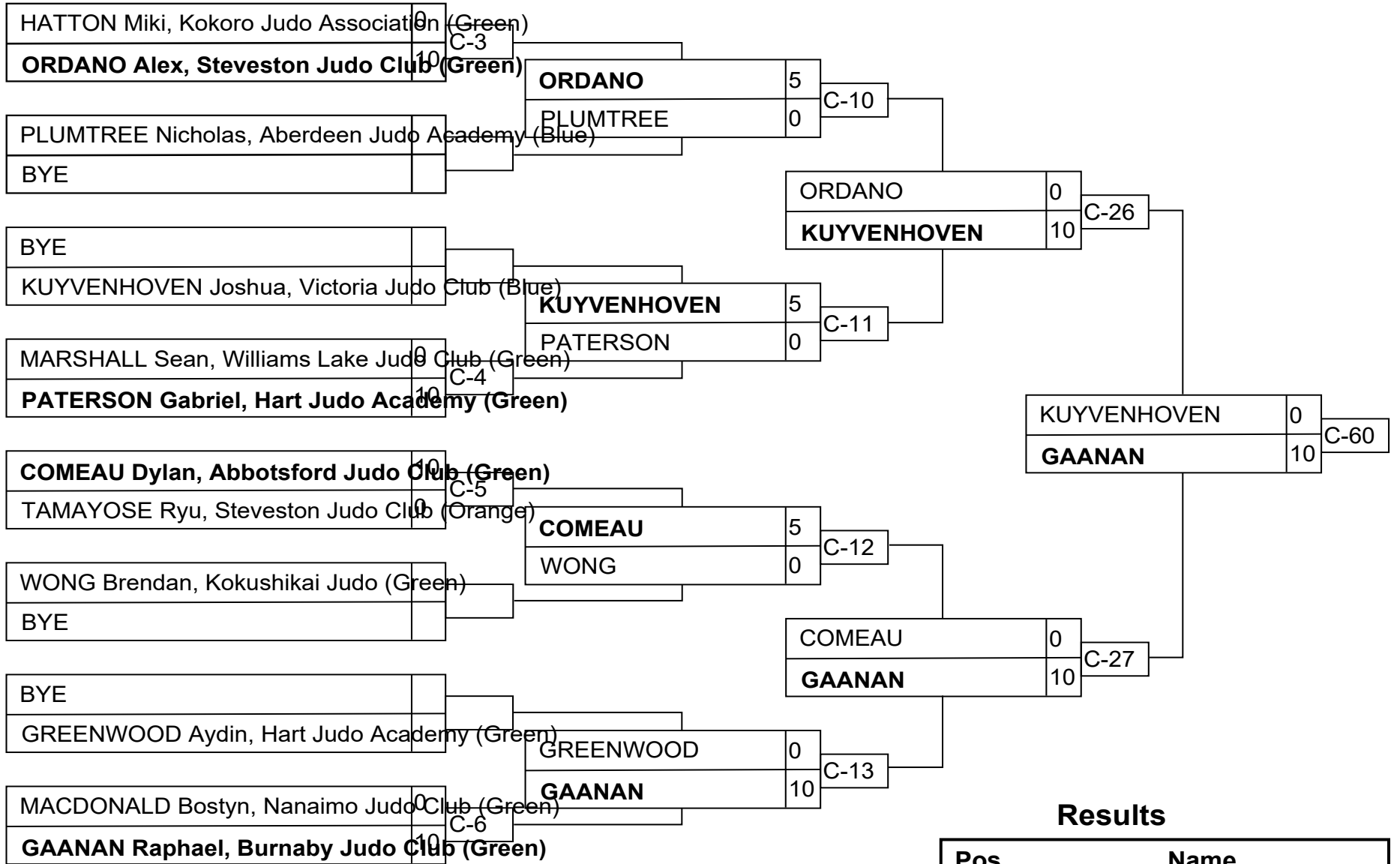

Results

Pos	Name
1	GAANAN Raphael, Burnaby Judo Club
2	KUYVENHOVEN Joshua, Victoria Judo Club
3	WONG Brendan, Kokushikai Judo (Green)
3	PATERSON Gabriel, Hart Judo Academy

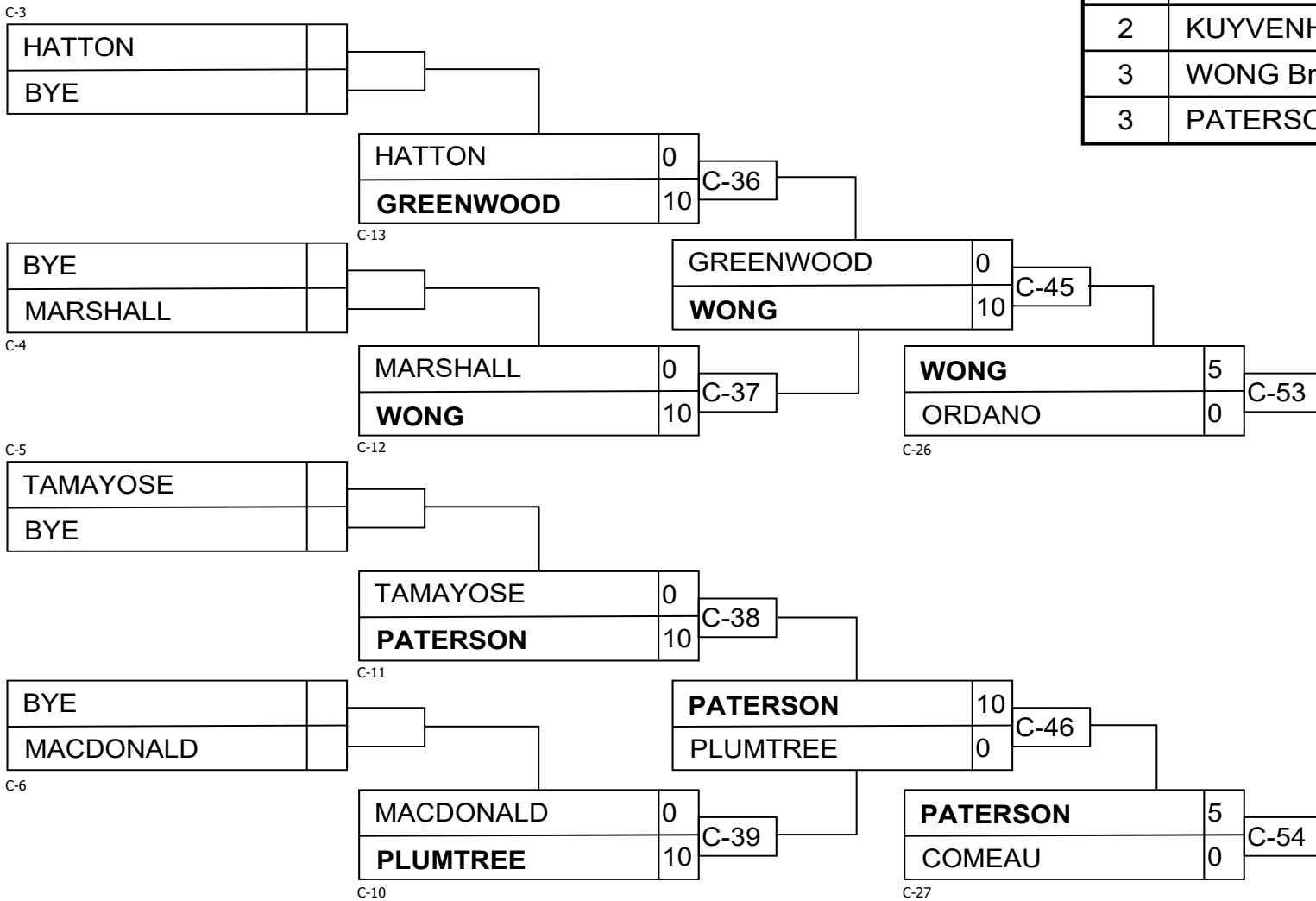

Competitors

#	Name	Grade	Club	1	2	3	4	5	Wins	Pts	Pos
1	HILL Brandon	Orange	Hart Judo Academy	XX	10	5	10		3	25	2
2	GIRVIN Fergus	Green	Campbell River Judo Club		XX				0	0	5
3	AUCH Wyatt	Blue	Lake Country Judo Club		10	XX	10		2	20	3
4	SESSA Layne	Orange	Revelstoke Judo Club		10		XX		1	10	4
5	KOMNENOVIC Kai	Green	Steveston Judo Club	10	10	10	10	XX	4	40	1

Matches

Match	White			Blue	Result	Time	Code
C-8	SESSA Layne	4	5	KOMNENOVIC Kai	0 - 10	2:46	IPO
C-9	HILL Brandon	1	2	GIRVIN Fergus	10 - 0	1:36	IPO
C-20	AUCH Wyatt	3	4	SESSA Layne	10 - 0	0:54	IPO
C-21	HILL Brandon	1	5	KOMNENOVIC Kai	0 - 10	2:33	IPO
C-24	GIRVIN Fergus	2	3	AUCH Wyatt	0 - 10	0:32	IPO
C-25	HILL Brandon	1	4	SESSA Layne	10 - 0	2:40	IPO
C-34	AUCH Wyatt	3	5	KOMNENOVIC Kai	0 - 10	1:18	IPO
C-35	GIRVIN Fergus	2	4	SESSA Layne	0 - 10	1:32	IPO
C-43	HILL Brandon	1	3	AUCH Wyatt	5 - 0	3:00	WAZ
C-44	GIRVIN Fergus	2	5	KOMNENOVIC Kai	0 - 10	0:39	IPO

Results

Pos	Name
1	KOMNENOVIC Kai, Steveston Judo Club
2	HILL Brandon, Hart Judo Academy
3	AUCH Wyatt, Lake Country Judo Club
4	SESSA Layne, Revelstoke Judo Club

Competitors

#	Name	Grade	Club	1	2	3	4	5	Wins	Pts	Pos
1	WILSON Jaeden	Green	Williams Lake Judo Club	XX	10		10	10	3	30	2
2	ROBSON Zachary	Green	Kokushikai Judo		XX		5	10	2	15	3
3	PETROVIC Nikola	Blue	Burnaby Judo Club	10	10	XX	10	10	4	40	1
4	MICHALUK Alexander	Orange	Shidokai Judo				XX		0	0	5
5	VEILLETTE Noah	Green	Steveston Judo Club				10	XX	1	10	4

Matches

Match	White	Blue	Result	Time	Code
B-6	MICHALUK Alexander 4 5	VEILLETTE Noah	0 - 10	1:12	IPO
B-7	WILSON Jaeden 1 2	ROBSON Zachary	10 - 0	0:12	IPO
B-8	PETROVIC Nikola 3 4	MICHALUK Alexander	10 - 0	0:27	IPO
B-9	WILSON Jaeden 1 5	VEILLETTE Noah	10 - 0	0:42	IPO
B-21	ROBSON Zachary 2 3	PETROVIC Nikola	0 - 10	0:09	IPO
B-22	WILSON Jaeden 1 4	MICHALUK Alexander	10 - 0	0:08	IPO
B-33	PETROVIC Nikola 3 5	VEILLETTE Noah	10 - 0	0:41	IPO
B-34	ROBSON Zachary 2 4	MICHALUK Alexander	5 - 0	3:00	WAZ
B-46	WILSON Jaeden 1 3	PETROVIC Nikola	0 - 10	2:19	IPO
B-47	ROBSON Zachary 2 5	VEILLETTE Noah	10 - 0	0:01	FUS

Results

Pos	Name
1	PETROVIC Nikola, Burnaby Judo Club
2	WILSON Jaeden, Williams Lake Judo Club
3	ROBSON Zachary, Kokushikai Judo
4	VEILLETTE Noah, Steveston Judo Club

Competitors A

#	Name	Grade	Club	1	2	3	4	Wins	Pts	Pos
1	DANILKOV Klavdia	Green	Burnaby Judo Club	XX	10	10		2	20	1
2	LOLIEVA Rakiia	Green	Burnaby Judo Club		XX		5	1	5	3
3	CORBETT Brooke	Green	Hart Judo Academy		10	XX	10	2	20	2
4	MORITA Ayumi	Green	Police Judo Junior	5			XX	1	5	4

Matches A

Match	White	Blue	Result	Time	Code
1	DANILKOV Klavdia 1 2	LOLIEVA Rakiia	10 - 0	2:45	IPO
2	CORBETT Brooke 3 4	MORITA Ayumi	10 - 0	0:55	IPO
4	DANILKOV Klavdia 1 3	CORBETT Brooke	10 - 0	1:51	IPO
5	LOLIEVA Rakiia 2 4	MORITA Ayumi	5 - 0	5:27	GSW
7	DANILKOV Klavdia 1 4	MORITA Ayumi	0 - 5	4:00	WAZ
8	LOLIEVA Rakiia 2 3	CORBETT Brooke	0 - 10	0:44	IPO

Competitors B

#	Name	Grade	Club	5	6	7	Wins	Pts	Pos
5	GOTO Tami	Brown	Prince George Judo Club	XX	10	10	2	20	1
6	KO Hailey	Green	Burnaby Judo Club		XX		0	0	3
7	SHEEHAN Olivia	Blue	Campbell River Judo Club		5	XX	1	5	2

Matches B

Match	White	Blue	Result	Time	Code
3	GOTO Tami 5 6	KO Hailey	10 - 0	0:30	IPO
6	GOTO Tami 5 7	SHEEHAN Olivia	10 - 0	2:04	IPO
9	KO Hailey 6 7	SHEEHAN Olivia	0 - 5	4:00	WAZ

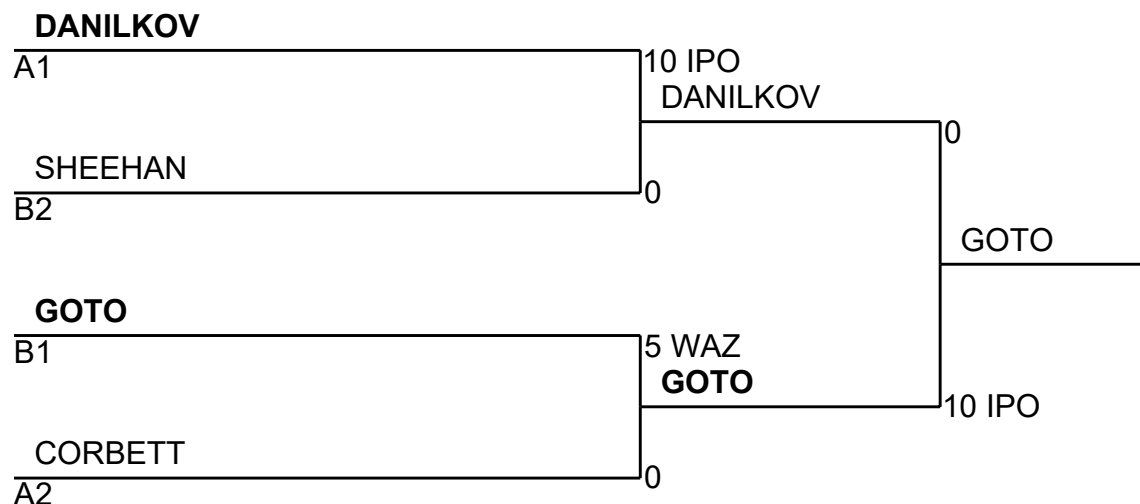

Results

Pos	Name
1	GOTO Tami, Prince George Judo Club
2	DANILKOV Klavdia, Burnaby Judo Club
3	SHEEHAN Olivia, Campbell River Judo Club
3	CORBETT Brooke, Hart Judo Academy



U18 Female -57Kg

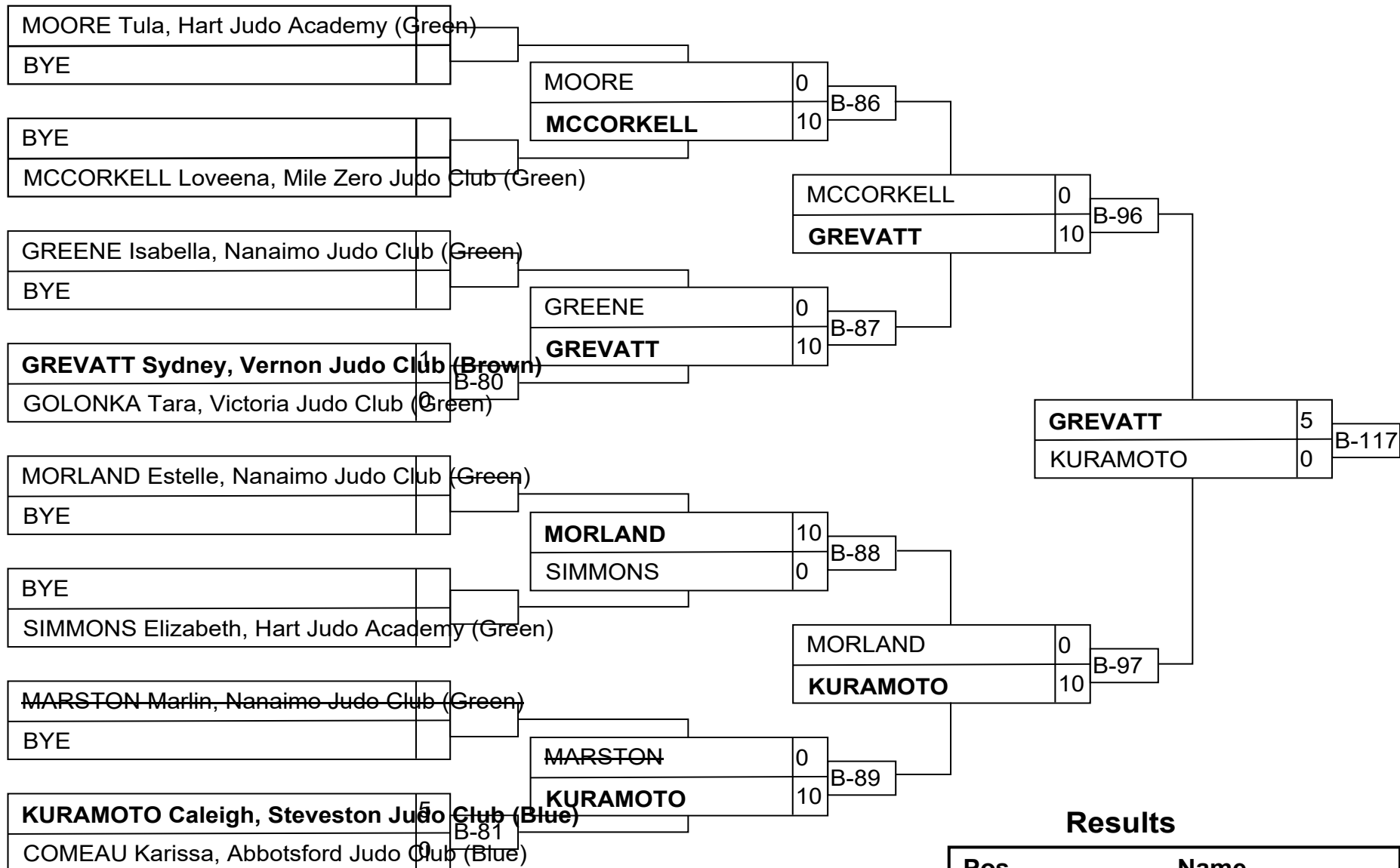

Results

Pos	Name
1	GREVATT Sydney, Vernon Judo Club
2	KURAMOTO Caleigh, Steveston Judo
3	GOLONKA Tara, Victoria Judo Club (G
3	COMEAU Karissa, Abbotsford Judo Cl

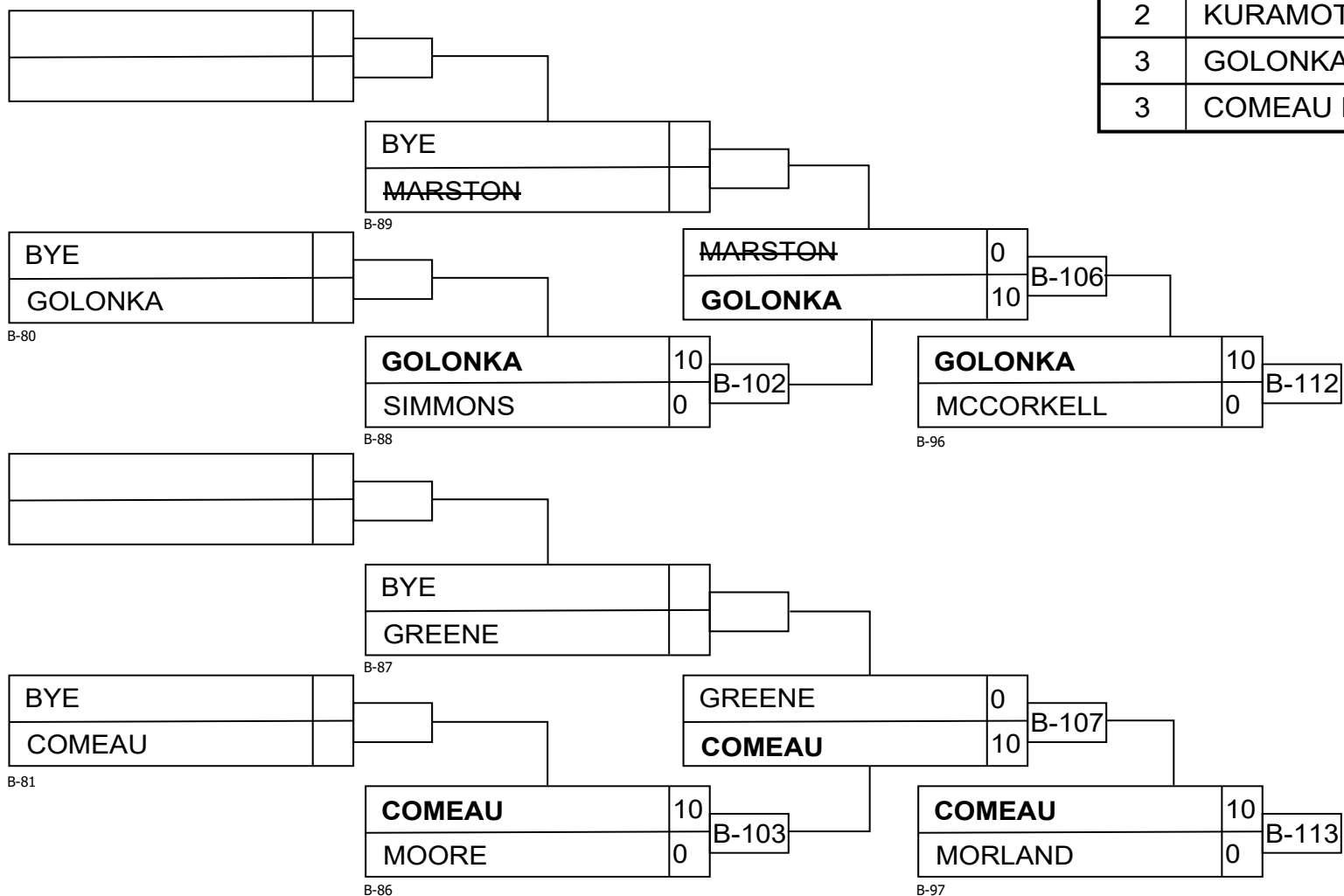



U18 Female -70Kg

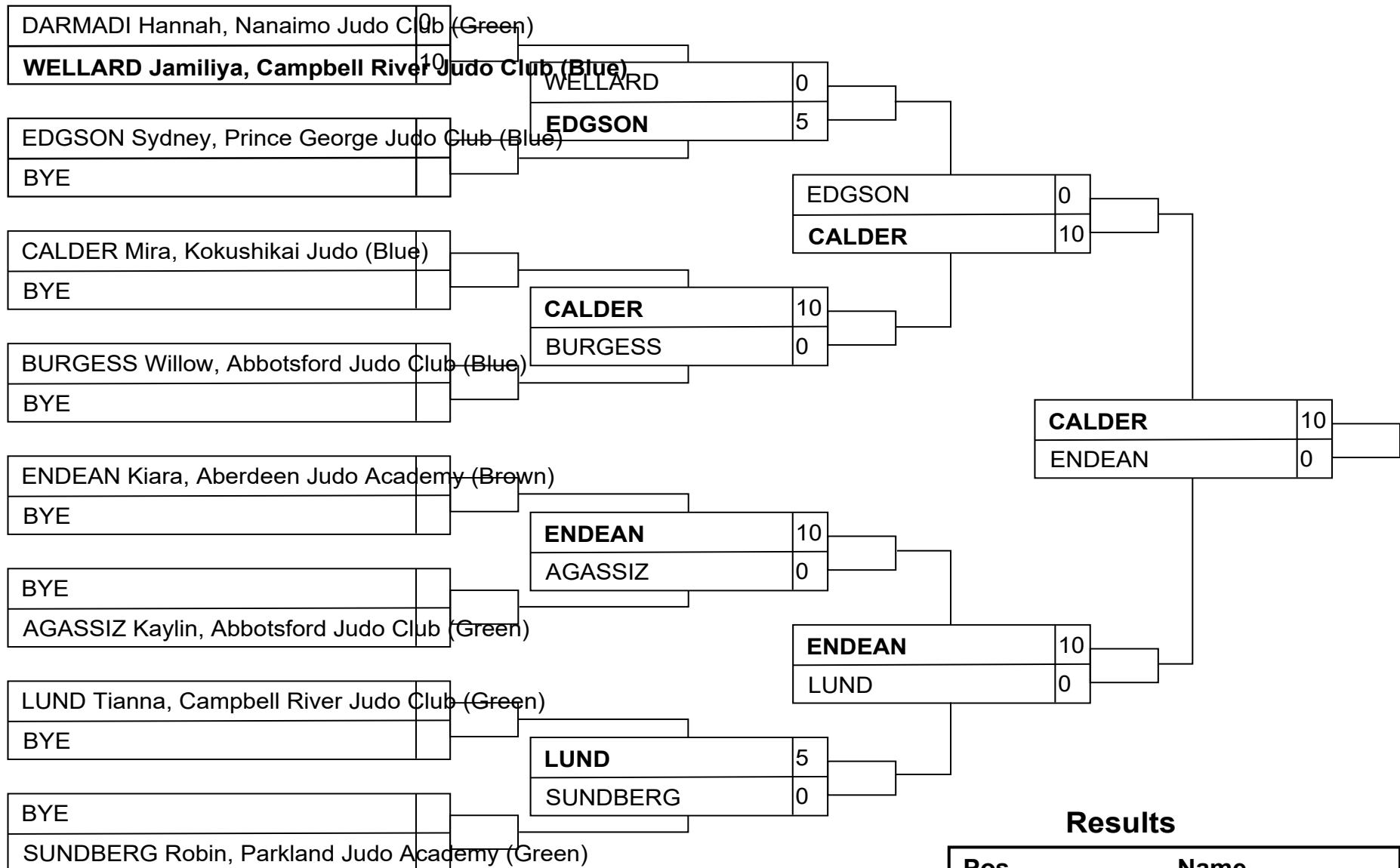

Results

Pos	Name
1	CALDER Mira, Kokushikai Judo (Blue)
2	ENDEAN Kiara, Aberdeen Judo Academy (Brown)
3	EDGSON Sydney, Prince George Judo Club (Blue)
3	WELLARD Jamiliya, Campbell River Judo Club (Blue)

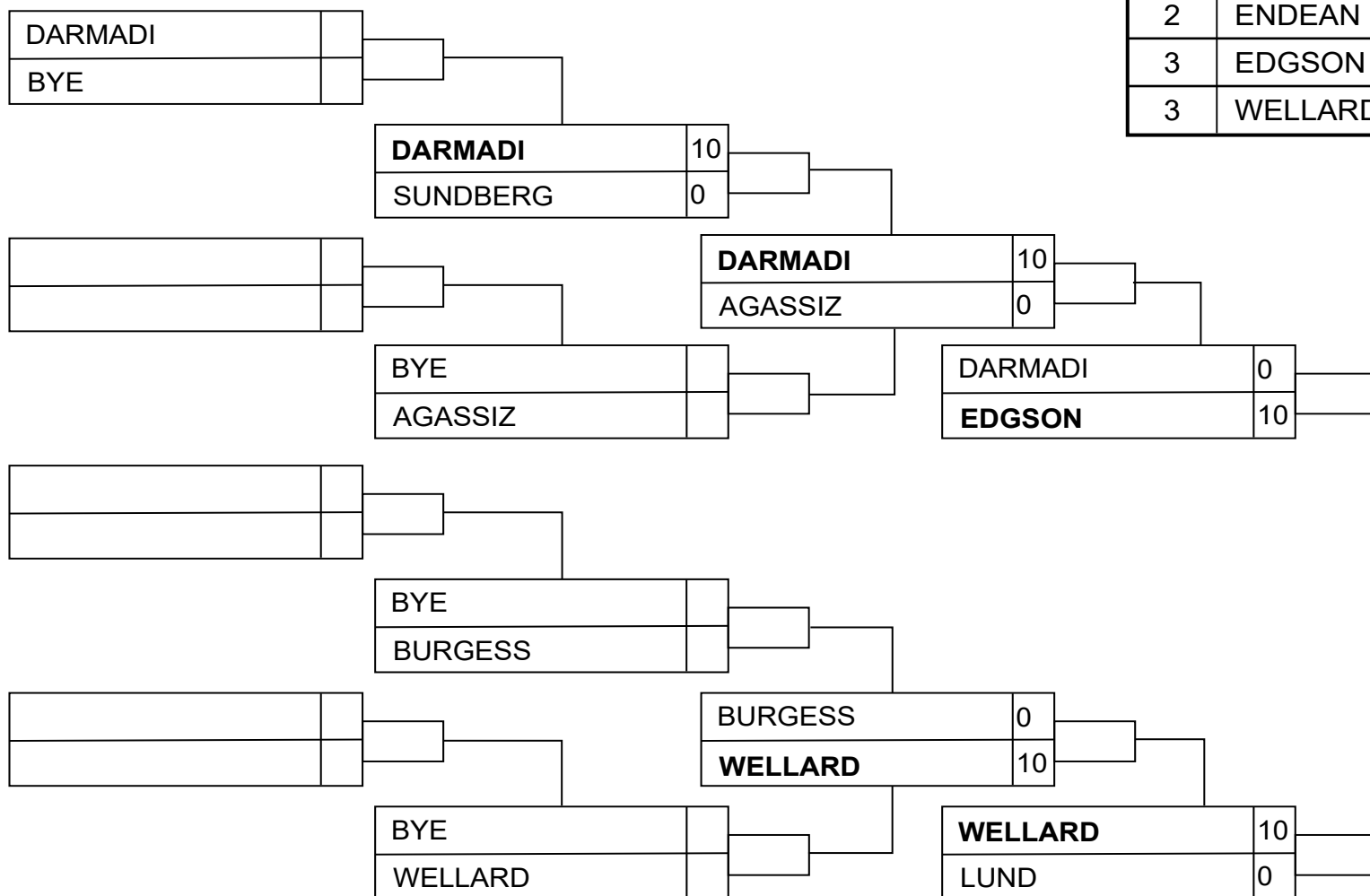

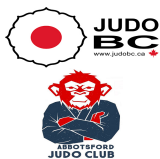

U18 Male -46Kg

Competitors A

#	Name	Grade	Club	1	2	3	Wins	Pts	Pos
1	DARMADI Joshua	Green	Nanaimo Judo Club	XX	10	10	2	20	1
2	POTTS Marcus	Green	Shidokai Judo		XX	10	1	10	2
3	VOFSI Michael	Blue	Port Coquitlam Judo Club			XX	0	0	3

Matches A

Match	White	Blue	Result	Time	Code
1	DARMADI Joshua	1 2 POTTS Marcus	10 - 0	1:18	IPO
3	DARMADI Joshua	1 3 VOFSI Michael	10 - 0	1:16	IPO
5	POTTS Marcus	2 3 VOFSI Michael	10 - 0	1:46	IPO

Competitors B

#	Name	Grade	Club	4	5	6	Wins	Pts	Pos
4	KEYES Aidan	Green	Police Judo Junior	XX			0	0	3
5	YOUNG Asher	Blue	Hart Judo Academy	10	XX	10	2	20	1
6	LOWE Jacob	Green	Victoria Judo Club	5		XX	1	5	2

Matches B

Match	White	Blue	Result	Time	Code
2	KEYES Aidan	4 5 YOUNG Asher	0 - 10	2:27	IPO
4	KEYES Aidan	4 6 LOWE Jacob	0 - 5	4:00	WAZ
6	YOUNG Asher	5 6 LOWE Jacob	10 - 0	1:03	IPO

DARMADI

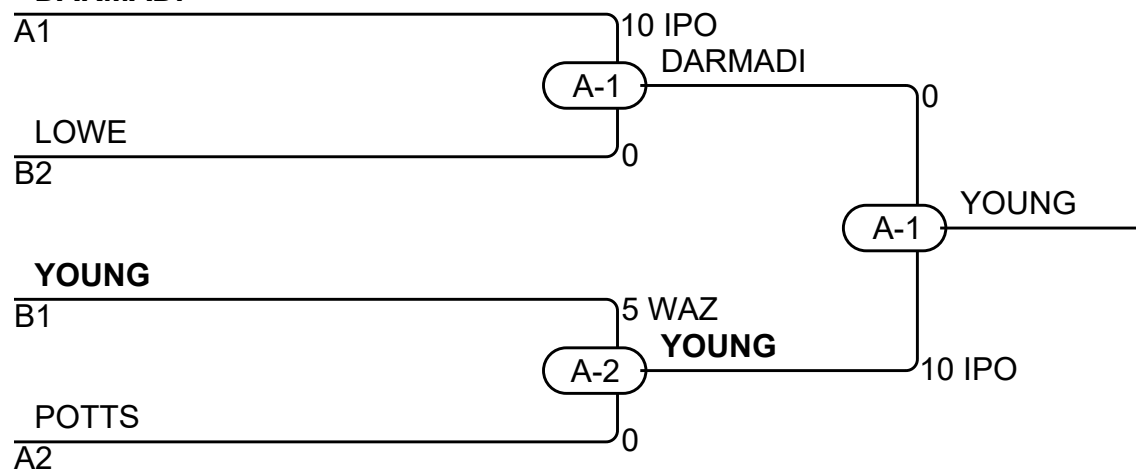

Results

Pos	Name
1	YOUNG Asher, Hart Judo Academy
2	DARMADI Joshua, Nanaimo Judo Club
3	LOWE Jacob, Victoria Judo Club
3	POTTS Marcus, Shidokai Judo

U18 Male -55Kg

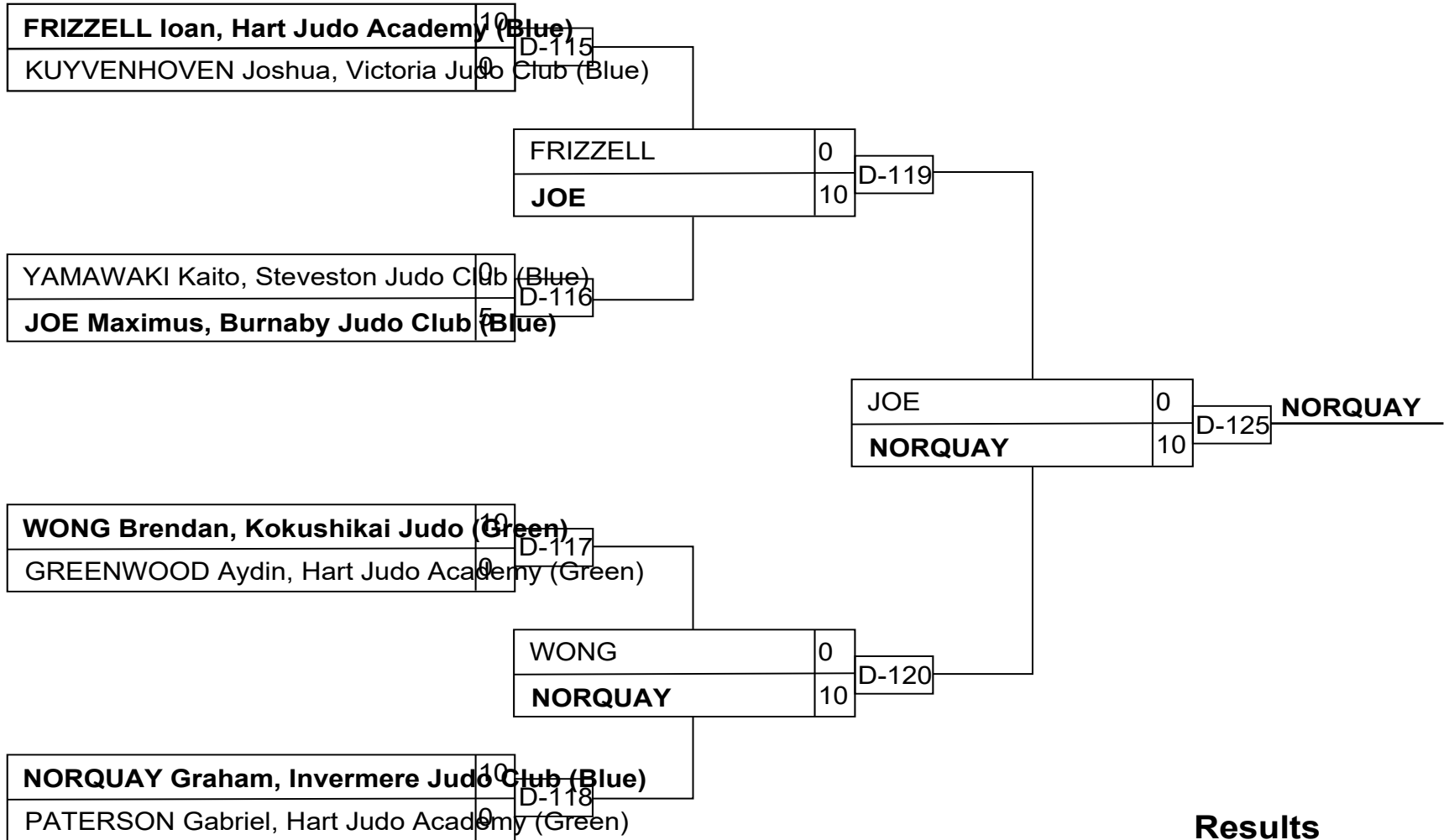

Results

Pos	Name
1	NORQUAY Graham, Invermere Judo Club (Blue)
2	JOE Maximus, Burnaby Judo Club (Blue)
3	FRIZZELL Ioan, Hart Judo Academy (Blue)
3	KUYVENHOVEN Joshua, Victoria Judo Club (Blue)

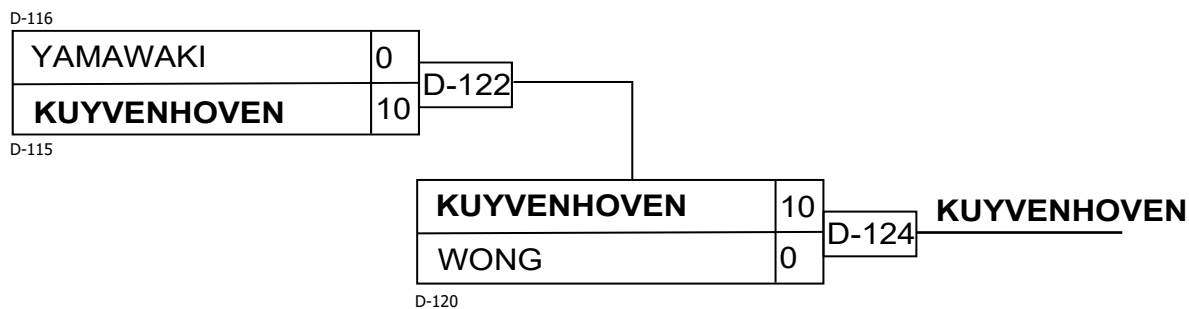
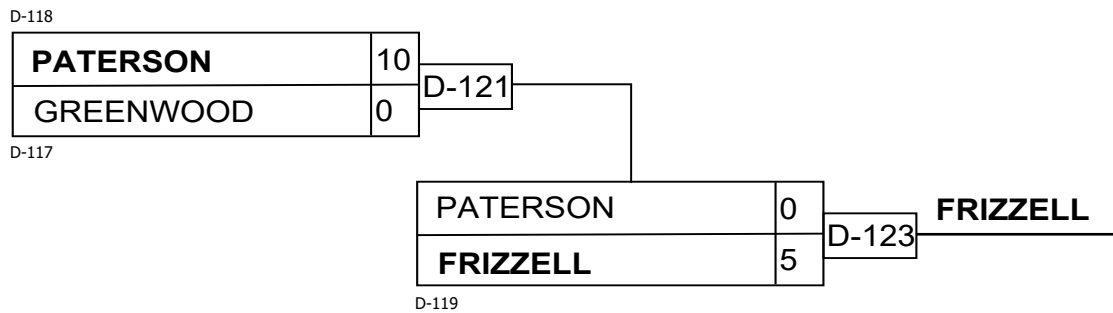

U18 Male -60Kg

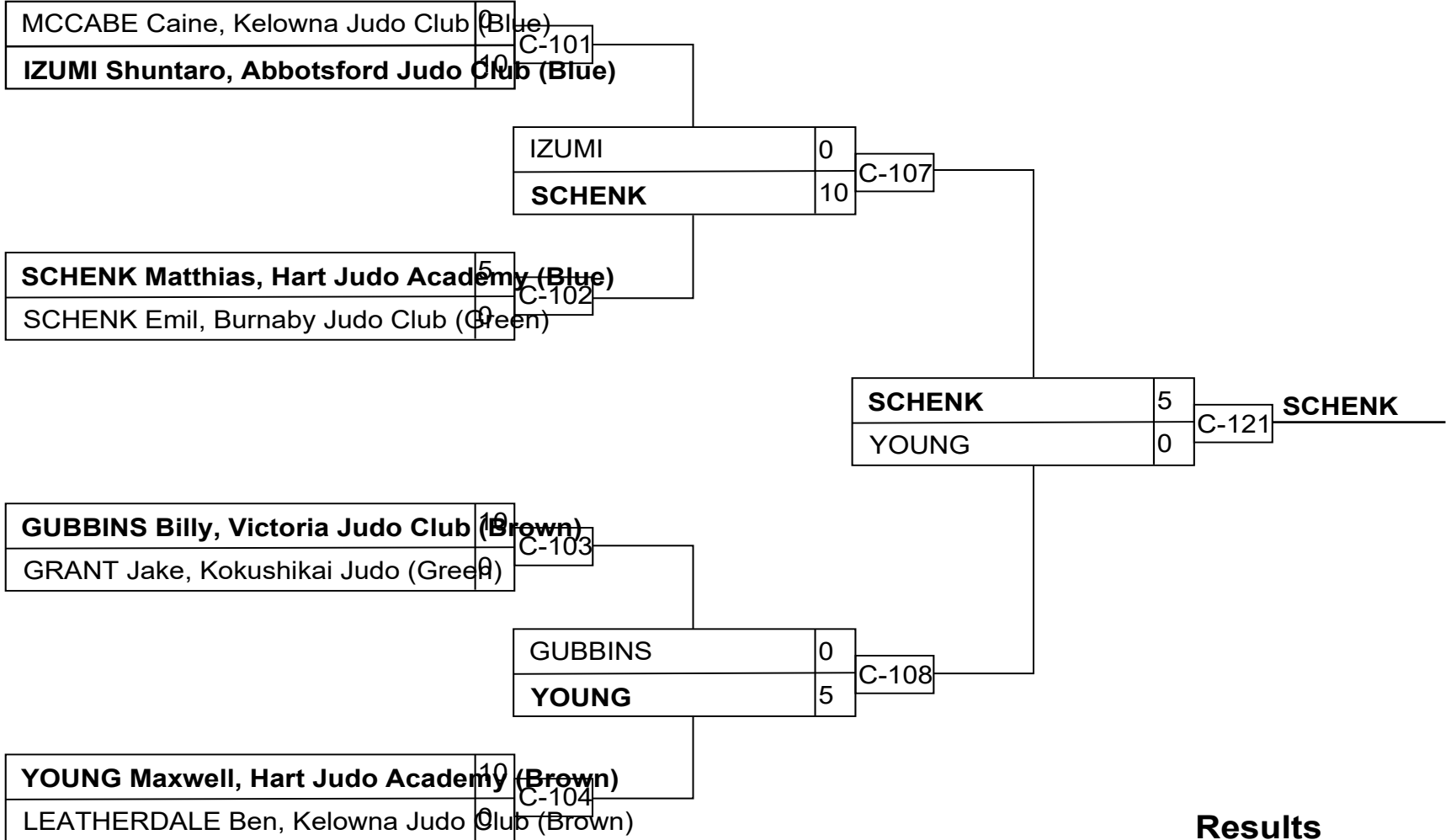

Results

Pos	Name
1	SCHENK Matthias, Hart Judo Academy
2	YOUNG Maxwell, Hart Judo Academy
3	LEATHERDALE Ben, Kelowna Judo Club
3	SCHENK Emil, Burnaby Judo Club

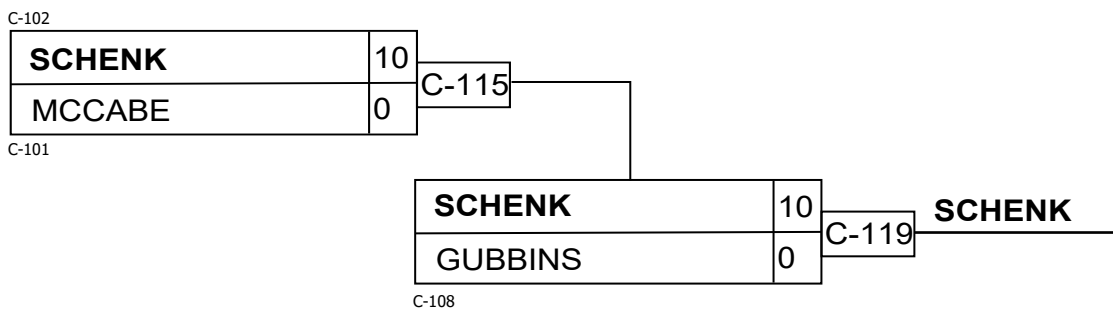
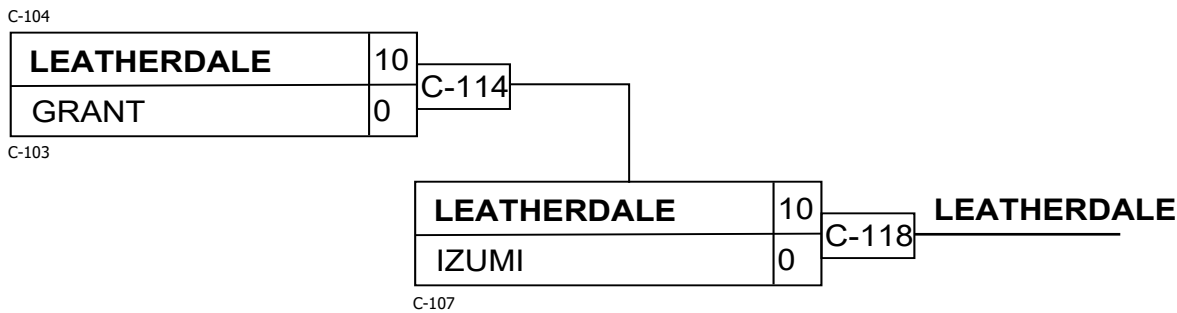



U18 Male -66Kg

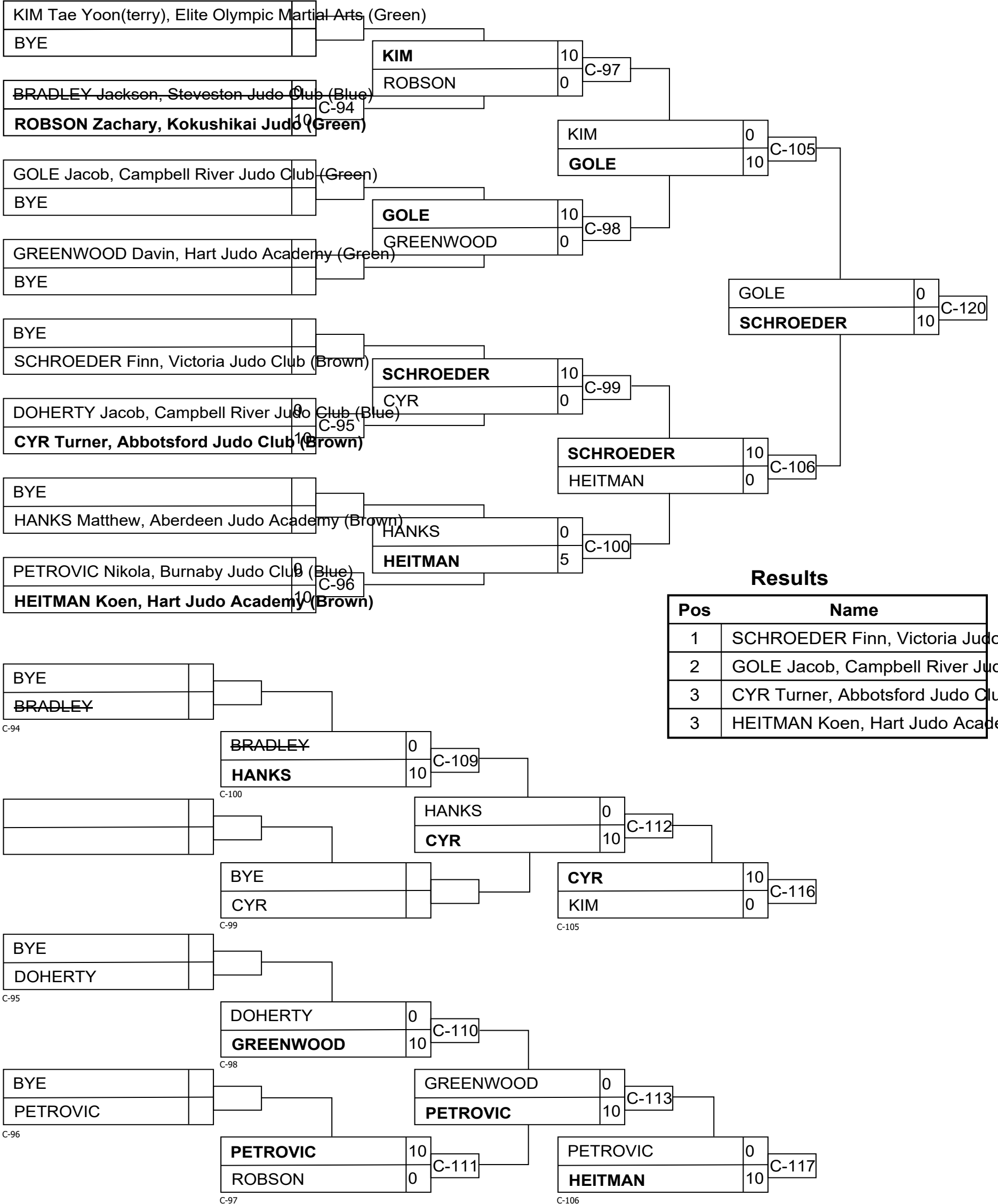

Results

Pos	Name
1	SCHROEDER Finn, Victoria Judo Club
2	GOLE Jacob, Campbell River Judo Club
3	CYR Turner, Abbotsford Judo Club (Brown)
3	HEITMAN Koen, Hart Judo Academy (Brown)

C-94

C-100

C-105

C-95

C-98

C-96

C-97

C-106



U18 Male -73Kg

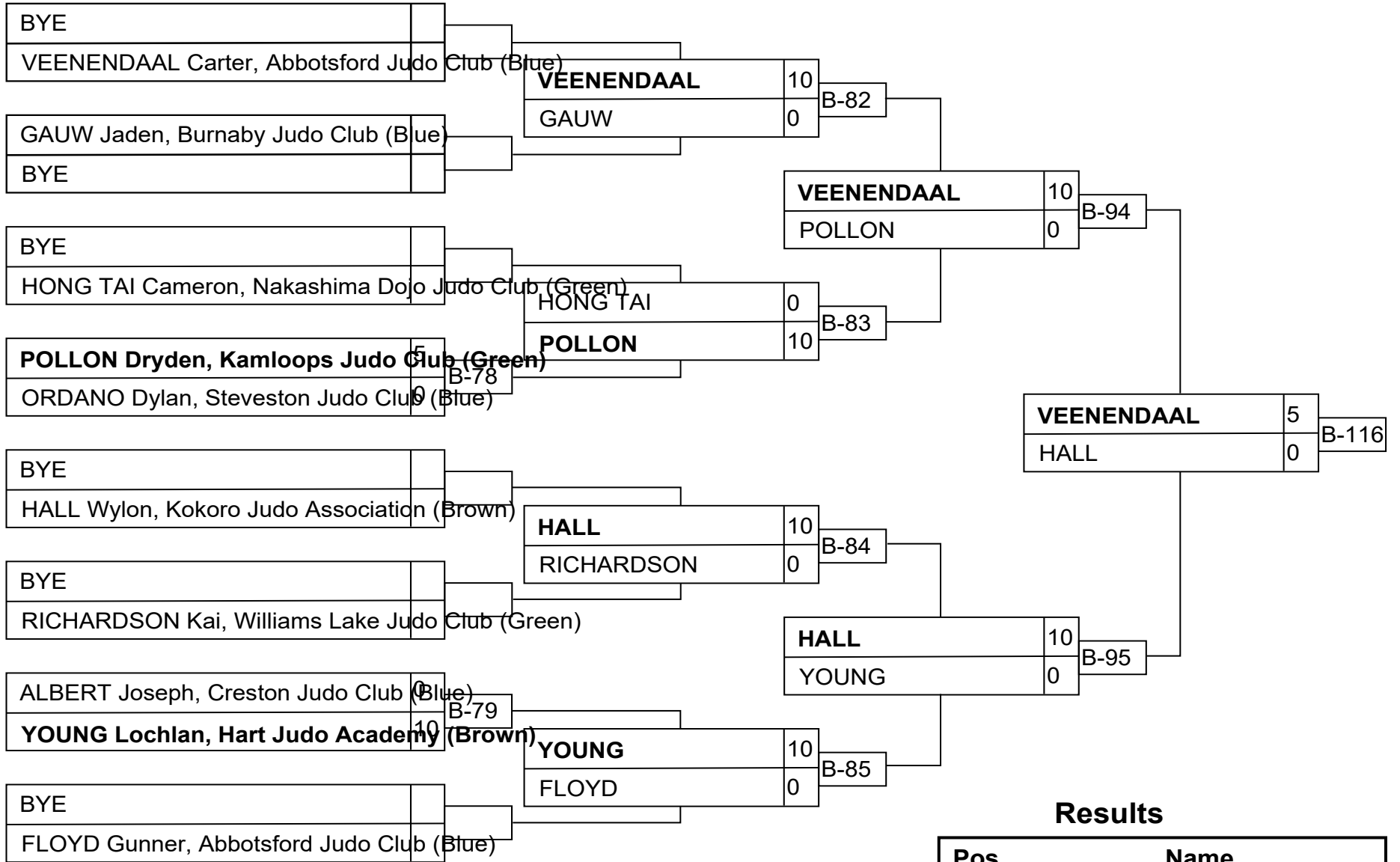

Results

Pos	Name
1	VEENENDAAL Carter, Abbotsford Judo Club (Blue)
2	HALL Wylon, Kokoro Judo Association (Brown)
3	FLOYD Gunner, Abbotsford Judo Club (Blue)
3	YOUNG Lochlan, Hart Judo Academy (Brown)

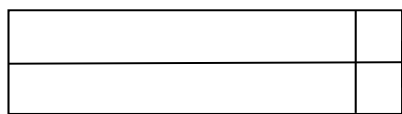

B-85

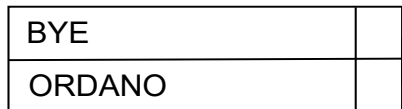

B-78



B-84

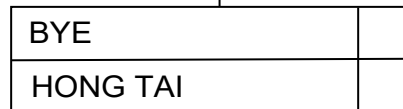
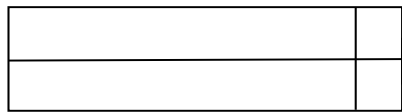

B-83

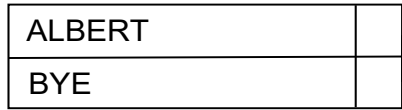

B-79

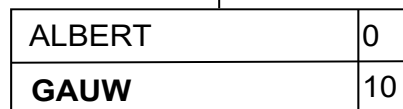

B-82

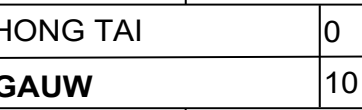

B-105

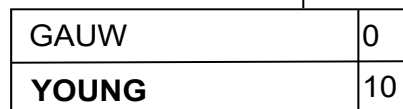

B-95

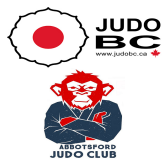

U21 Female -48Kg

Competitors

#	Name	Grade	Club	1	2	3	Wins	Pts	Pos
1	DANILKOV Klavdia	Green	Burnaby Judo Club	XX		5	1	5	2
2	GOTO Tami	Brown	Prince George Judo Club	5	XX	10	2	15	1
3	CORBETT Brooke	Green	Hart Judo Academy			XX	0	0	3

Matches

Match	White			Blue	Result	Time	Code
D-17	DANILKOV Klavdia	1	2	GOTO Tami	0 - 5	4:00	WAZ
D-27	DANILKOV Klavdia	1	3	CORBETT Brooke	5 - 0	4:00	WAZ
D-35	GOTO Tami	2	3	CORBETT Brooke	10 - 0	2:14	IPO

Results

Pos	Name
1	GOTO Tami, Prince George Judo Club
2	DANILKOV Klavdia, Burnaby Judo Club

Competitors

#	Name	Grade	Club	1	2	3	4	Wins	Pts	Pos
1	GREVATT Sydney	Brown	Vernon Judo Club	XX			5	1	5	4
2	COMEAU Karissa	Blue	Abbotsford Judo Club	5	XX	10		2	15	1
3	KURAMOTO Caleigh	Blue	Steveston Judo Club	5		XX		1	5	3
4	COOLICAN Tiffany	Shodan	Victoria Judo Club		1	5	XX	2	6	2

Matches

Match	White	Blue	Result	Time	Code
1	GREVATT Sydney	1 2 COMEAU Karissa	0 - 5	5:31	GSW
2	KURAMOTO Caleigh	3 4 COOLICAN Tiffany	0 - 5	4:00	WAZ
3	GREVATT Sydney	1 3 KURAMOTO Caleigh	0 - 5	7:42	GSW
4	COMEAU Karissa	2 4 COOLICAN Tiffany	0 - 1	6:20	GSD
5	GREVATT Sydney	1 4 COOLICAN Tiffany	5 - 0	10:22	GSW
6	COMEAU Karissa	2 3 KURAMOTO Caleigh	10 - 0	0:36	IPO

Results

Pos	Name
1	COMEAU Karissa, Abbotsford Judo Club
2	COOLICAN Tiffany, Victoria Judo Club
3	KURAMOTO Caleigh, Steveston Judo Club
4	GREVATT Sydney, Vernon Judo Club

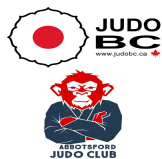

U21 Female -70Kg

Competitors

#	Name	Grade	Club	1	2	3	Wins	Pts	Pos
1	ZAWADZKI Nikki	Brown	Burnaby Judo Club	XX	10	10	2	20	1
2	DARMADI Hannah	Green	Nanaimo Judo Club		XX	10	1	10	2
3	SUNDBERG Robin	Green	Parkland Judo Academy			XX	0	0	3

Matches

Match	White	Blue	Result	Time	Code
1	ZAWADZKI Nikki	1 2 DARMADI Hannah	10 - 0	1:53	IPO
2	ZAWADZKI Nikki	1 3 SUNDBERG Robin	10 - 0	1:23	IPO
3	DARMADI Hannah	2 3 SUNDBERG Robin	10 - 0	2:38	IPO

Results

Pos	Name
1	ZAWADZKI Nikki, Burnaby Judo Club
2	DARMADI Hannah, Nanaimo Judo Club

Competitors

#	Name	Grade	Club	1	2	1	2	1	2	Wins	Pts	Pos
1	NORQUAY Graham	Blue	Invermere Judo Club	XX	10	XX		XX		1	10	2
2	FRIZZELL Ioan	Blue	Hart Judo Academy		XX	5	XX	5	XX	2	10	1

Matches

Match	White			Blue	Result	Time	Code
D-22	NORQUAY Graham	1	2	FRIZZELL Ioan	10 - 0	1:34	IPO
D-31	FRIZZELL Ioan	2	1	NORQUAY Graham	5 - 0	4:57	GSW
D-40	NORQUAY Graham	1	2	FRIZZELL Ioan	0 - 5	4:00	WAZ

Results

Pos	Name
1	FRIZZELL Ioan, Hart Judo Academy
2	NORQUAY Graham, Invermere Judo Club



U21 Male -60Kg

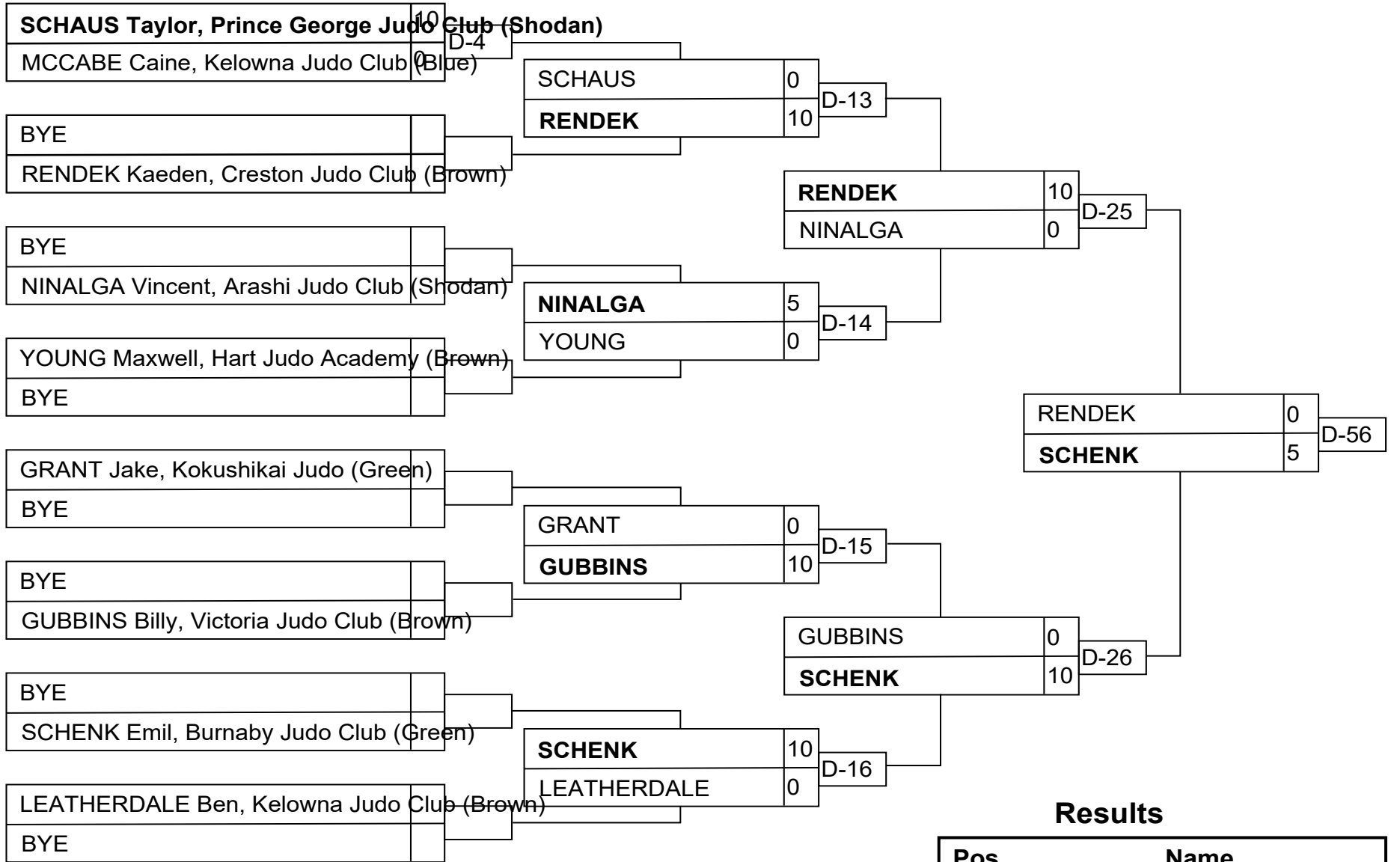

Results

Pos	Name
1	SCHENK Emil, Burnaby Judo Club (Green)
2	RENDEK Kaeden, Creston Judo Club (Brown)
3	NINALGA Vincent, Arashi Judo Club (Shodan)
3	YOUNG Maxwell, Hart Judo Academy (Brown)

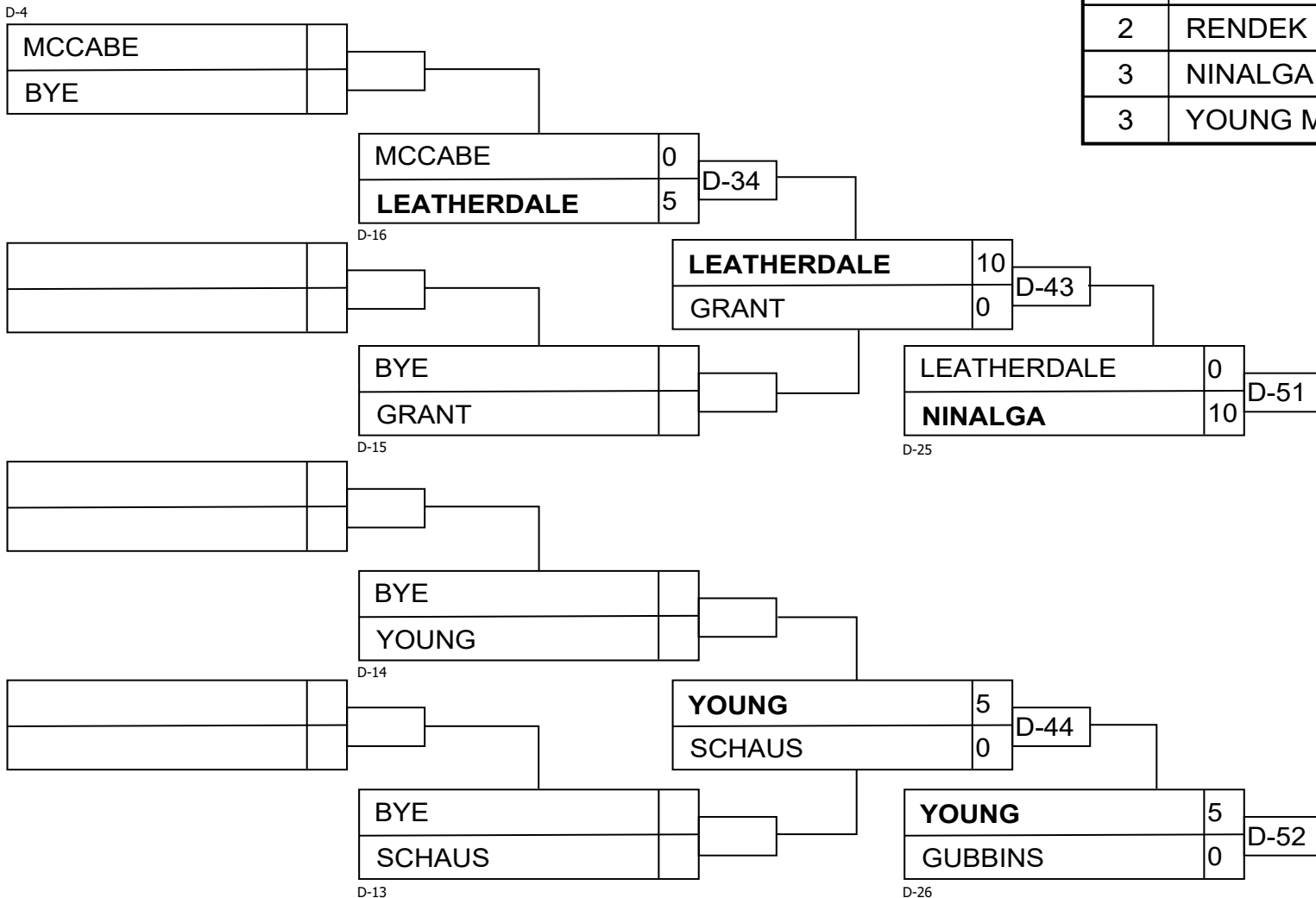

Competitors A

#	Name	Grade	Club	1	2	3	4	Wins	Pts	Pos
1	CYR Turner	Brown	Abbotsford Judo Club	XX		10	5	2	15	2
2	SCHROEDER Finn	Brown	Victoria Judo Club	10	XX	10	10	3	30	1
3	GREENWOOD Davin	Green	Hart Judo Academy			XX		0	0	4
4	HANKS Matthew	Brown	Aberdeen Judo Academy			10	XX	1	10	3

Matches A

Match	White	Blue	Result	Time	Code
B-15	CYR Turner 1 2	SCHROEDER Finn	0 - 10	3:41	IPO
B-16	GREENWOOD Davin 3 4	HANKS Matthew	0 - 10	1:08	IPO
B-27	CYR Turner 1 3	GREENWOOD Davin	10 - 0	0:26	IPO
B-28	SCHROEDER Finn 2 4	HANKS Matthew	10 - 0	0:41	IPO
B-40	CYR Turner 1 4	HANKS Matthew	5 - 0	4:00	WAZ
B-41	SCHROEDER Finn 2 3	GREENWOOD Davin	10 - 0	1:59	IPO

Competitors B

#	Name	Grade	Club	5	6	7	Wins	Pts	Pos
5	BRADLEY Jackson	Blue	Steveston Judo Club	XX			0	0	3
6	ST-AMOUR Georges	Shodan	Abbotsford Judo Club	10	XX	10	2	20	1
7	HEITMAN Koen	Brown	Hart Judo Academy	10		XX	1	10	2

Matches B

Match	White	Blue	Result	Time	Code
B-17	BRADLEY Jackson 5 6	ST-AMOUR Georges	0 - 10	2:22	KIK
B-29	BRADLEY Jackson 5 7	HEITMAN Koen	0 - 10	0:00	KIK
B-42	ST-AMOUR Georges 6 7	HEITMAN Koen	10 - 0	3:57	IPO

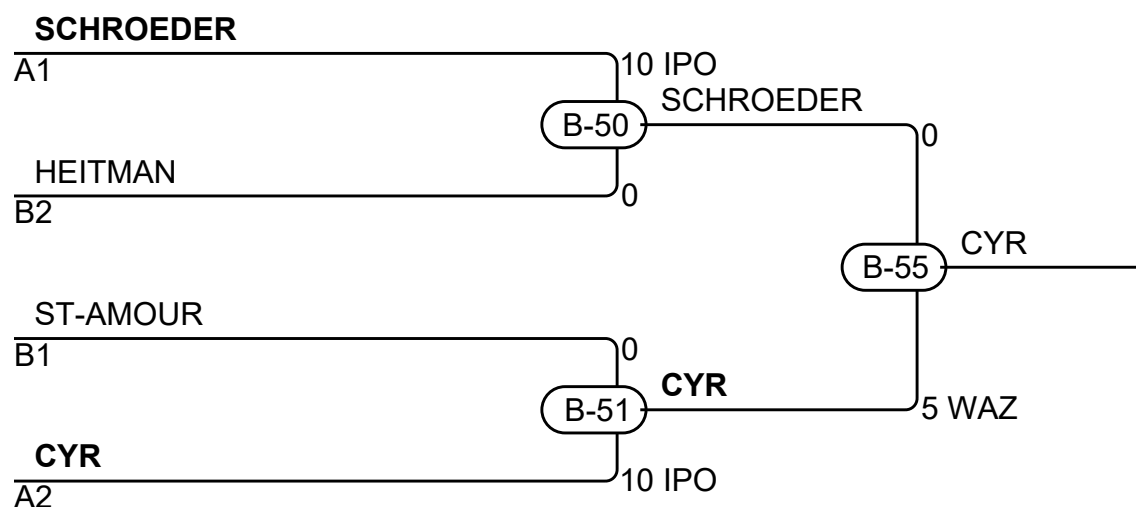

Results

Pos	Name
1	CYR Turner, Abbotsford Judo Club
2	SCHROEDER Finn, Victoria Judo Club
3	HEITMAN Koen, Hart Judo Academy
3	ST-AMOUR Georges, Abbotsford Judo Club

U21 Male -73Kg

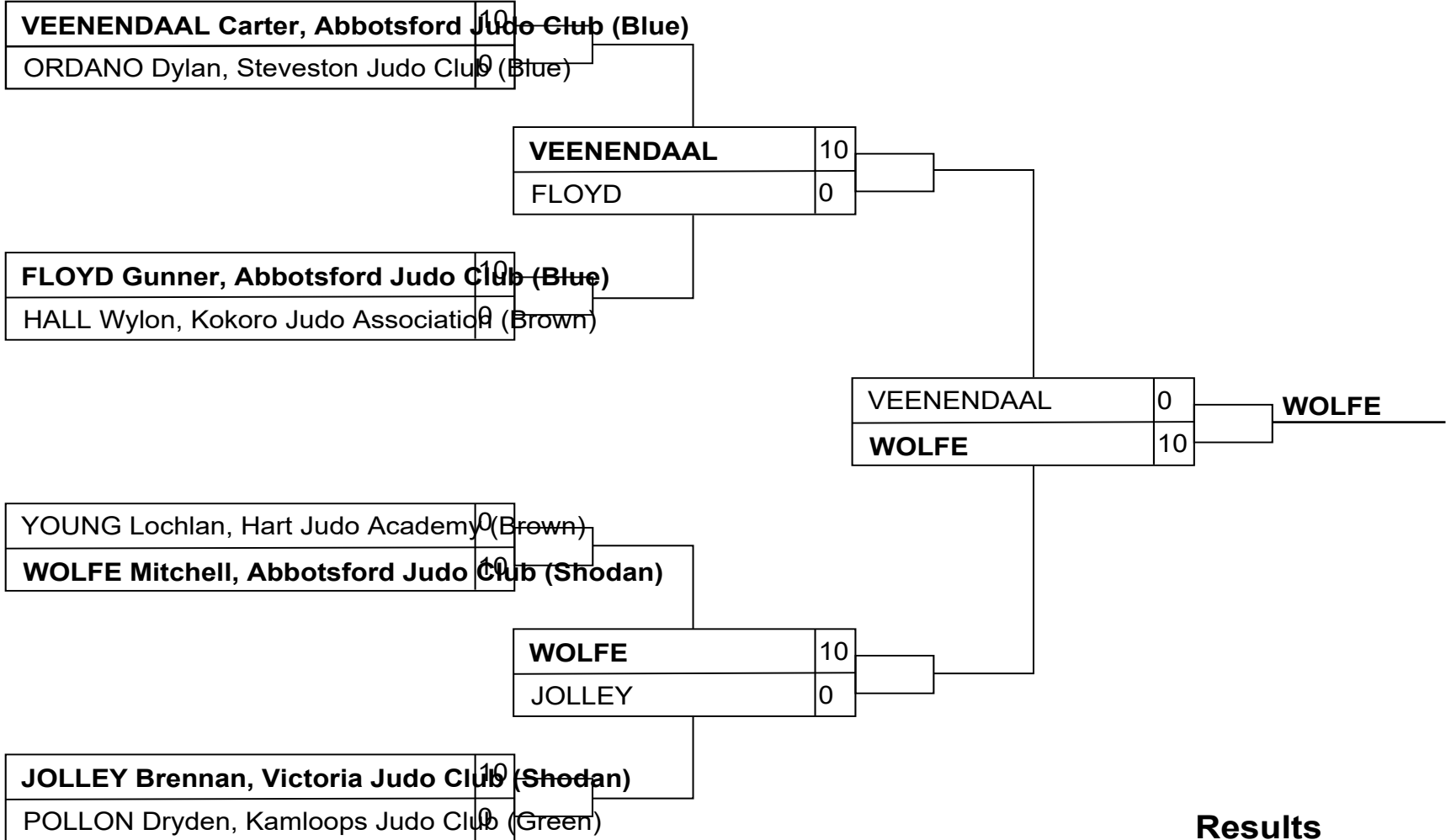

Results

Pos	Name
1	WOLFE Mitchell, Abbotsford Judo Club
2	VEENENDAAL Carter, Abbotsford Judo Club
3	FLOYD Gunner, Abbotsford Judo Club
3	JOLLEY Brennan, Victoria Judo Club

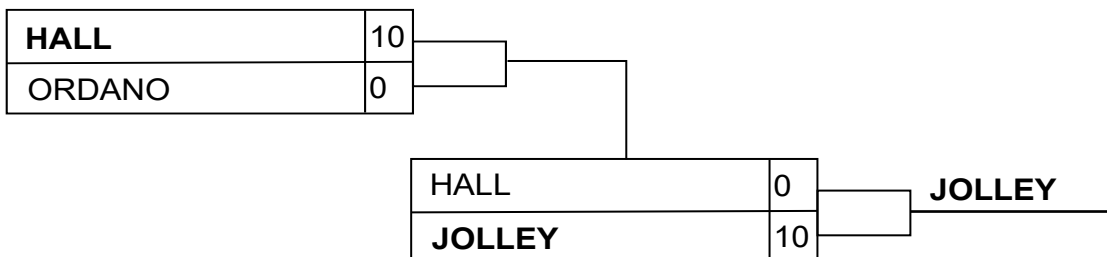
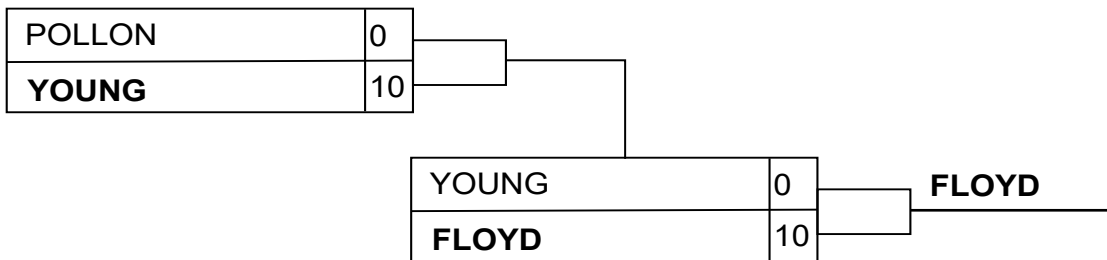

Competitors

#	Name	Grade	Club	1	2	3	4	Wins	Pts	Pos
1	GRANT Maxwell	Shodan	Victoria Judo Club	XX				0	0	4
2	MINNICK Jackson	Shodan	Victoria Judo Club	10	XX		10	2	20	2
3	RYDER Ian	Shodan	Steveston Judo Club	10	10	XX	10	3	30	1
4	HARRIS Payton	Brown	Abbotsford Judo Club	10			XX	1	10	3

Matches

Match	White		Blue		Result	Time	Code
1	GRANT Maxwell	1	2	MINNICK Jackson	0 - 10	6:23	GSI
2	RYDER Ian	3	4	HARRIS Payton	10 - 0	1:34	IPO
3	GRANT Maxwell	1	3	RYDER Ian	0 - 10	1:46	IPO
4	MINNICK Jackson	2	4	HARRIS Payton	10 - 0	2:09	IPO
5	GRANT Maxwell	1	4	HARRIS Payton	0 - 10	3:10	IPO
6	MINNICK Jackson	2	3	RYDER Ian	0 - 10	1:09	IPO

Results

Pos	Name
1	RYDER Ian, Steveston Judo Club
2	MINNICK Jackson, Victoria Judo Club
3	HARRIS Payton, Abbotsford Judo Club

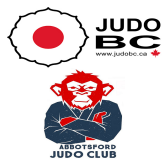

U21 Male +100Kg

Competitors

#	Name	Grade	Club	1	2	3	Wins	Pts	Pos
1	HAUGHTON Benjamin	Blue	Kamloops Judo Club	XX	10		1	10	2
2	GHASUMYAN Tigran	Green	Steveston Judo Club		XX		0	0	3
3	ALEXANDER Tristan	Shodan	Victoria Judo Club	10	10	XX	2	20	1

Matches

Match	White			Blue	Result	Time	Code
B-12	HAUGHTON Benjamin	1	2	GHASUMYAN Tigran	10 - 0	1:35	IPO
B-25	HAUGHTON Benjamin	1	3	ALEXANDER Tristan	0 - 10	2:10	IPO
B-37	GHASUMYAN Tigran	2	3	ALEXANDER Tristan	0 - 10	0:45	IPO

Results

Pos	Name
1	ALEXANDER Tristan, Victoria Judo Club
2	HAUGHTON Benjamin, Kamloops Judo Club

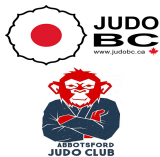

U21&Sr(M)Ne-Waza Hvy +90Kg

Competitors A

#	Name	Grade	Club	1	2	3	Wins	Pts	Pos
1	ROMANOV Andriy	Shodan	Burnaby Judo Club	XX	10	10	2	20	1
2	WIEBE David	Brown	Abbotsford Judo Club		XX	10	1	10	2
3	HAUGHTON Benjamin	Blue	Kamloops Judo Club			XX	0	0	3

Matches A

Match	White	Blue	Result	Time	Code
D-63	ROMANOV Andriy 1 2	WIEBE David	10 - 0	0:26	IPO
D-73	ROMANOV Andriy 1 3	HAUGHTON Benjamin	10 - 0	0:25	IPO
D-83	WIEBE David 2 3	HAUGHTON Benjamin	10 - 0	0:00	IPO

Competitors B

#	Name	Grade	Club	4	5	6	Wins	Pts	Pos
4	ALEXANDER Tristan	Shodan	Victoria Judo Club	XX	10		1	10	2
5	HUTCHINGS Daniel	Shodan	Abbotsford Judo Club		XX		0	0	3
6	TAGG Travis	Brown	Jiu Jitsu Invermere	10	10	XX	2	20	1

Matches B

Match	White	Blue	Result	Time	Code
D-64	ALEXANDER Tristan 4 5	HUTCHINGS Daniel	10 - 0	2:27	IPO
D-74	ALEXANDER Tristan 4 6	TAGG Travis	0 - 10	4:00	IPO
D-84	HUTCHINGS Daniel 5 6	TAGG Travis	0 - 10	2:09	IPO

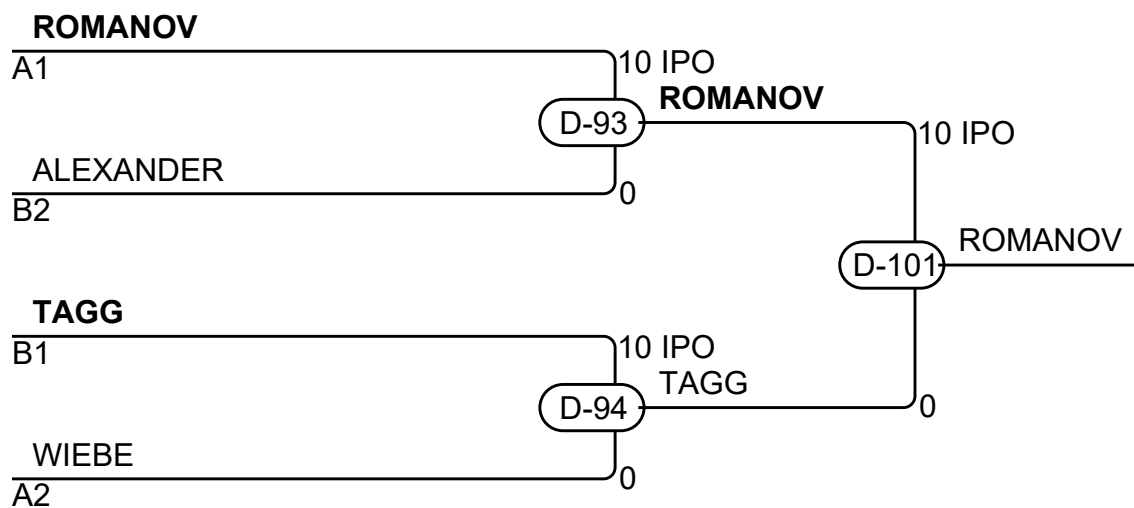

Results

Pos	Name
1	ROMANOV Andriy, Burnaby Judo Club
2	TAGG Travis, Jiu Jitsu Invermere
3	ALEXANDER Tristan, Victoria Judo Club
3	WIEBE David, Abbotsford Judo Club



U21&Sr(M)Ne-Waza Lit -73Kg

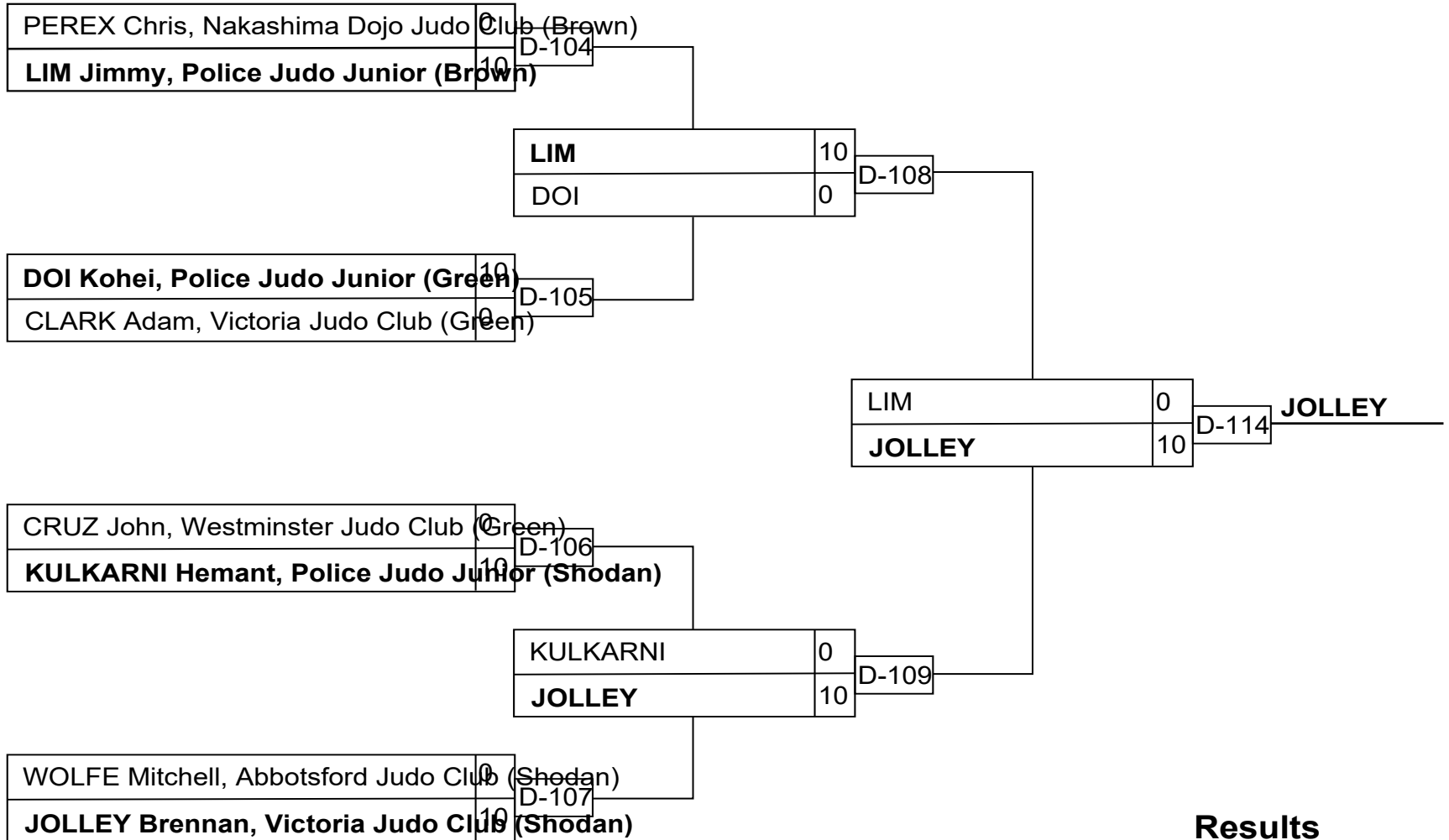

Results

Pos	Name
1	JOLLEY Brennan, Victoria Judo Club
2	LIM Jimmy, Police Judo Junior (Brown)
3	WOLFE Mitchell, Abbotsford Judo Club
3	KULKARNI Hemant, Police Judo Junior

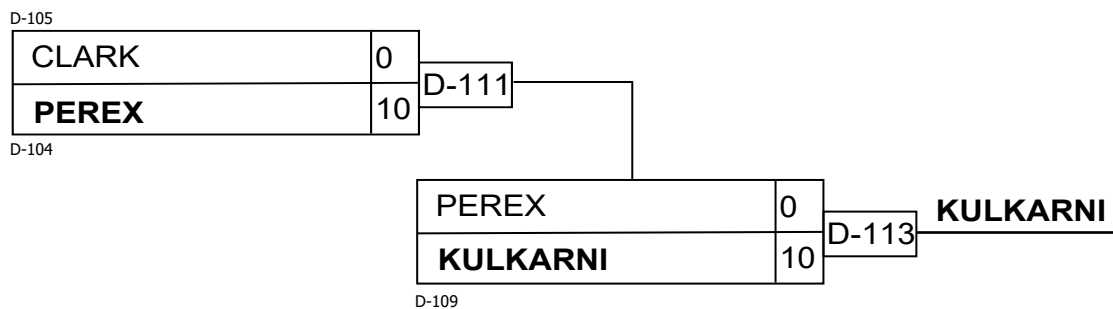
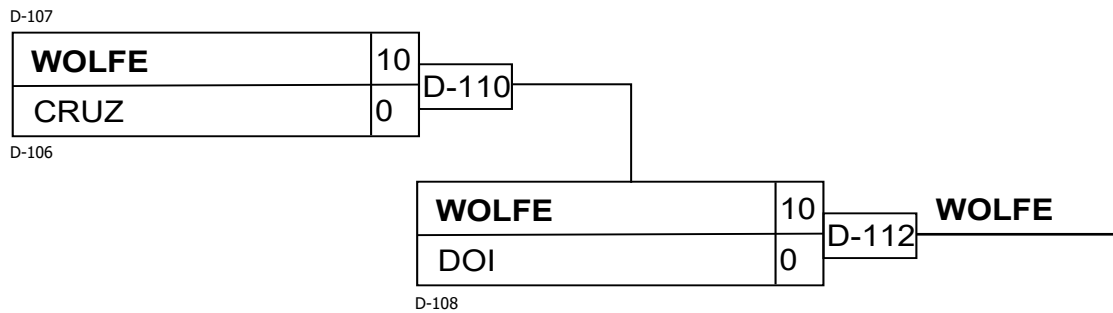



U21&Sr(M)Ne-Waza Med -90Kg

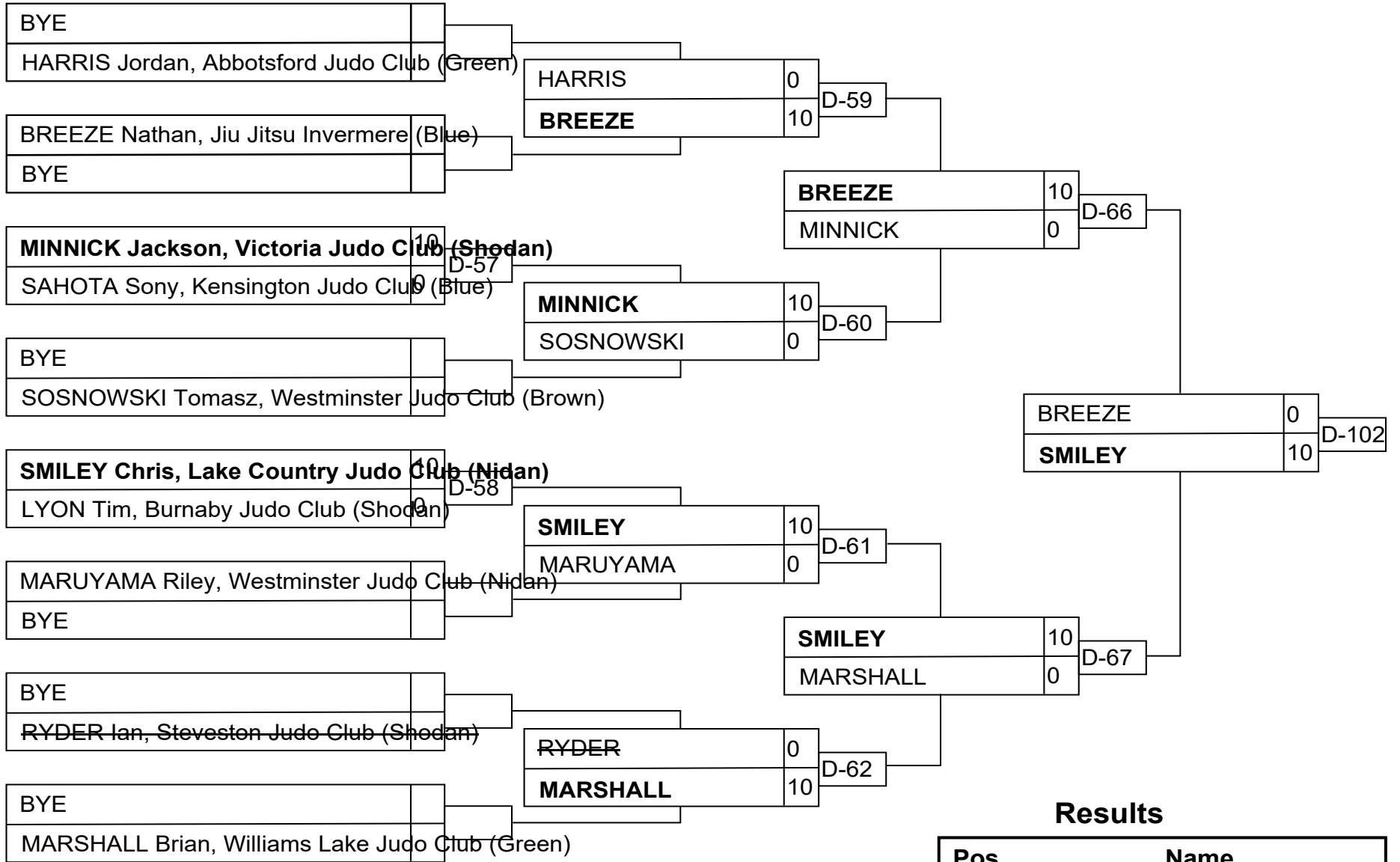

Results

Pos	Name
1	SMILEY Chris, Lake Country Judo Club
2	BREEZE Nathan, Jiu Jitsu Invermere (Blue)
3	MINNICK Jackson, Victoria Judo Club
3	LYON Tim, Burnaby Judo Club (Shodan)

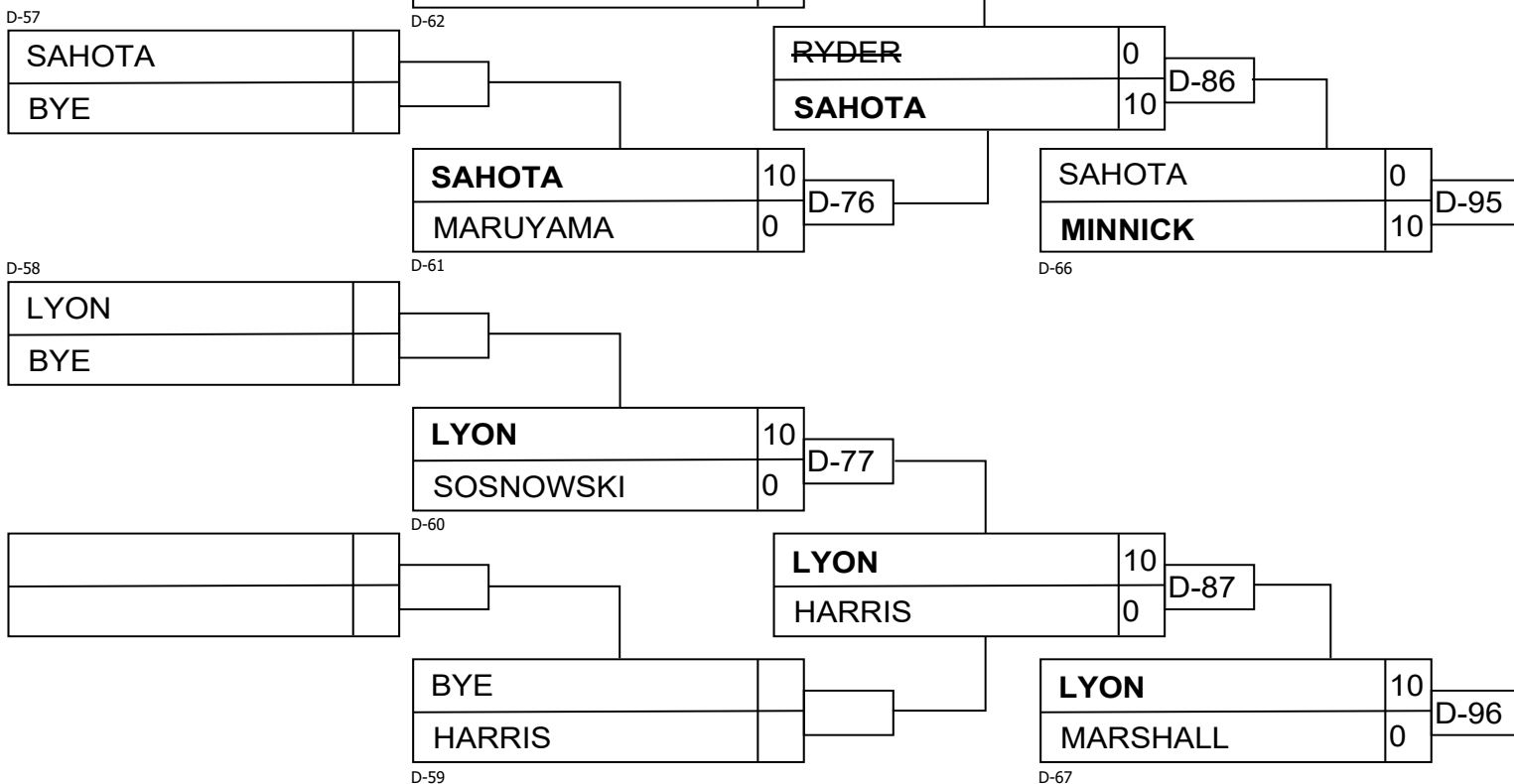

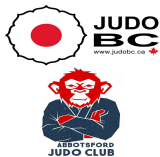

U21&Sr(W)Ne-Waza Hvy +57Kg

Competitors

#	Name	Grade	Club	1	2	3	Wins	Pts	Pos
1	JAMIESON Meghan	Nidan	Steveston Judo Club	XX	10		1	10	2
2	AUCH Anna	Blue	Lake Country Judo Club		XX		0	0	3
3	ZAWADZKI Nikki	Brown	Burnaby Judo Club	10	10	XX	2	20	1

Matches

Match	White			Blue	Result	Time	Code
D-65	JAMIESON Meghan	1	2	AUCH Anna	10 - 0	0:41	IPO
D-75	JAMIESON Meghan	1	3	ZAWADZKI Nikki	0 - 10	4:00	IPO
D-85	AUCH Anna	2	3	ZAWADZKI Nikki	0 - 10	1:17	IPO

Results

Pos	Name
1	ZAWADZKI Nikki, Burnaby Judo Club
2	JAMIESON Meghan, Steveston Judo Club

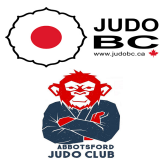

U21&Sr(W)Ne-Waza Lit -57Kg

Competitors A

#	Name	Grade	Club	1	2	3	Wins	Pts	Pos
1	SUDA Yuko	Brown	Police Judo Junior	XX			0	0	3
2	GELINAS Isabelle	Shodan	Mile Zero Judo Club	10	XX	10	2	20	1
3	DARMADI Jennifer	Green	Nanaimo Judo Club	10		XX	1	10	2

Matches A

Match	White	Blue	Result	Time	Code
D-68	SUDA Yuko	1 2 GELINAS Isabelle	0 - 10	0:56	IPO
D-78	SUDA Yuko	1 3 DARMADI Jennifer	0 - 10	0:33	IPO
D-88	GELINAS Isabelle	2 3 DARMADI Jennifer	10 - 0	2:23	IPO

Competitors B

#	Name	Grade	Club	4	5	6	Wins	Pts	Pos
4	COOLICAN Tiffany	Shodan	Victoria Judo Club	XX	10	10	2	20	1
5	NORENA Lizet	Green	Police Judo Junior		XX	10	1	10	2
6	HINTON Launa	Brown	Abbotsford Judo Club			XX	0	0	3

Matches B

Match	White	Blue	Result	Time	Code
D-69	COOLICAN Tiffany	4 5 NORENA Lizet	10 - 0	1:21	IPO
D-79	COOLICAN Tiffany	4 6 HINTON Launa	10 - 0	0:00	KIK
D-89	NORENA Lizet	5 6 HINTON Launa	10 - 0	0:00	KIK

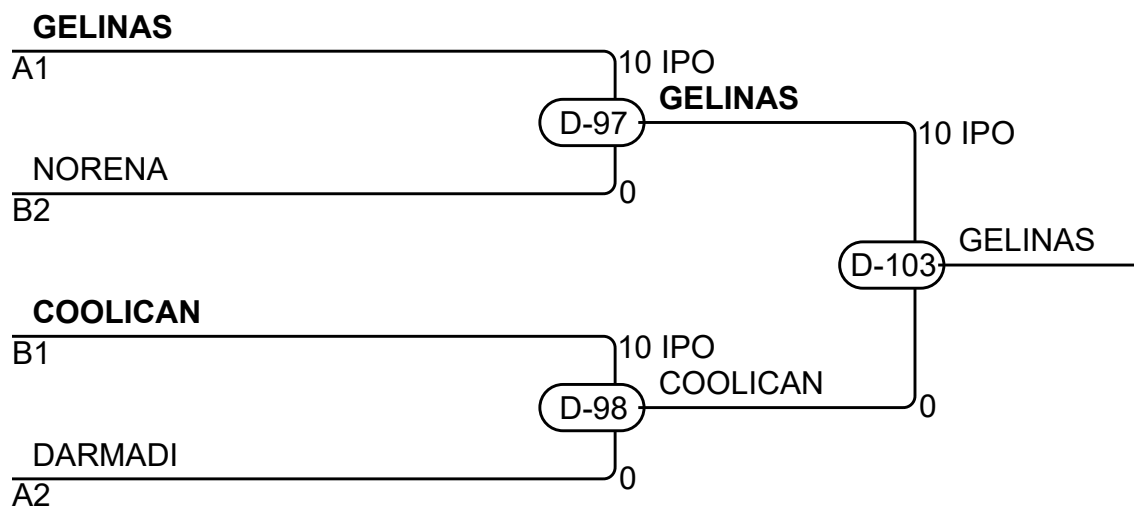

Results

Pos	Name
1	GELINAS Isabelle, Mile Zero Judo Club
2	COOLICAN Tiffany, Victoria Judo Club
3	NORENA Lizet, Police Judo Junior
3	DARMADI Jennifer, Nanaimo Judo Club