

Senior Female NW Light



Competitors

#	Name	Grade	Club	1	2	3	4	5	Wins	Pts	Pos
1	GLOVER Mariko	Brown	BC/Peak Judo Club	XX			18	20	2	38	3
2	OGAWA Naomi	Green	BC/Victoria Judo Club	20	XX	20	20	20	4	80	1
3	RUSSELL Judith	Blue	BC/Victoria Judo Club	2		XX	16	4	3	22	2
4	GREENE Isabella	Shodan	BC/Nanaimo Judo Club				XX	20	1	20	4
5	MOES Jennifer	Green	BC/Nanaimo Judo Club					XX	0	0	5

Matches

Match	White	Blue	Result	Time	Code
C-11	GREENE Isabella	4 5 MOES Jennifer	20 - 0	2:51	IPO
C-12	GLOVER Mariko	1 2 OGAWA Naomi	0 - 20	1:11	IPO
C-17	RUSSELL Judith	3 4 GREENE Isabella	16 - 2	4:00	
C-18	GLOVER Mariko	1 5 MOES Jennifer	20 - 0	1:45	IPO
C-25	OGAWA Naomi	2 3 RUSSELL Judith	20 - 0	0:37	IPO
C-26	GLOVER Mariko	1 4 GREENE Isabella	18 - 0	4:00	
C-40	RUSSELL Judith	3 5 MOES Jennifer	4 - 0	4:00	
C-41	OGAWA Naomi	2 4 GREENE Isabella	20 - 0	0:45	IPO
C-53	GLOVER Mariko	1 3 RUSSELL Judith	0 - 2	4:00	
C-54	OGAWA Naomi	2 5 MOES Jennifer	20 - 0	0:35	IPO

Results

Pos	Name
1	OGAWA Naomi, BC/Victoria Judo Club
2	RUSSELL Judith, BC/Victoria Judo Club
3	GLOVER Mariko, BC/Peak Judo Club
4	GREENE Isabella, BC/Nanaimo Judo Club

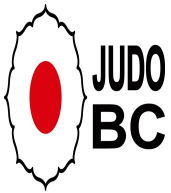

Senior Male NW Heavy



Competitors

#	Name	Grade	Club	1	2	3	Wins	Pts	Pos
1	TAMAYOSE Ryu	Blue/Brown	BC/Steveston Judo Club	XX			0	0	3
2	KAHLON Birinder	Green	BC/Nanaimo Judo Club	20	XX	20	2	40	1
3	VELASQUEZ KASAP Abel	Green	BC/Police Judo Junior	20		XX	1	20	2

Matches

Match	White	Blue	Result	Time	Code
C-29	TAMAYOSE Ryu 1 2	KAHLON Birinder	0 - 20	0:59	IPO
C-44	TAMAYOSE Ryu 1 3	VELASQUEZ KASAP Abel	2 - 20	4:00	IPO
C-57	KAHLON Birinder 2 3	VELASQUEZ KASAP Abel	20 - 0	2:01	IPO

Results

Pos	Name
1	KAHLON Birinder, BC/Nanaimo Judo Club
2	VELASQUEZ KASAP Abel, BC/Police Judo Junior

Senior Male NW Light

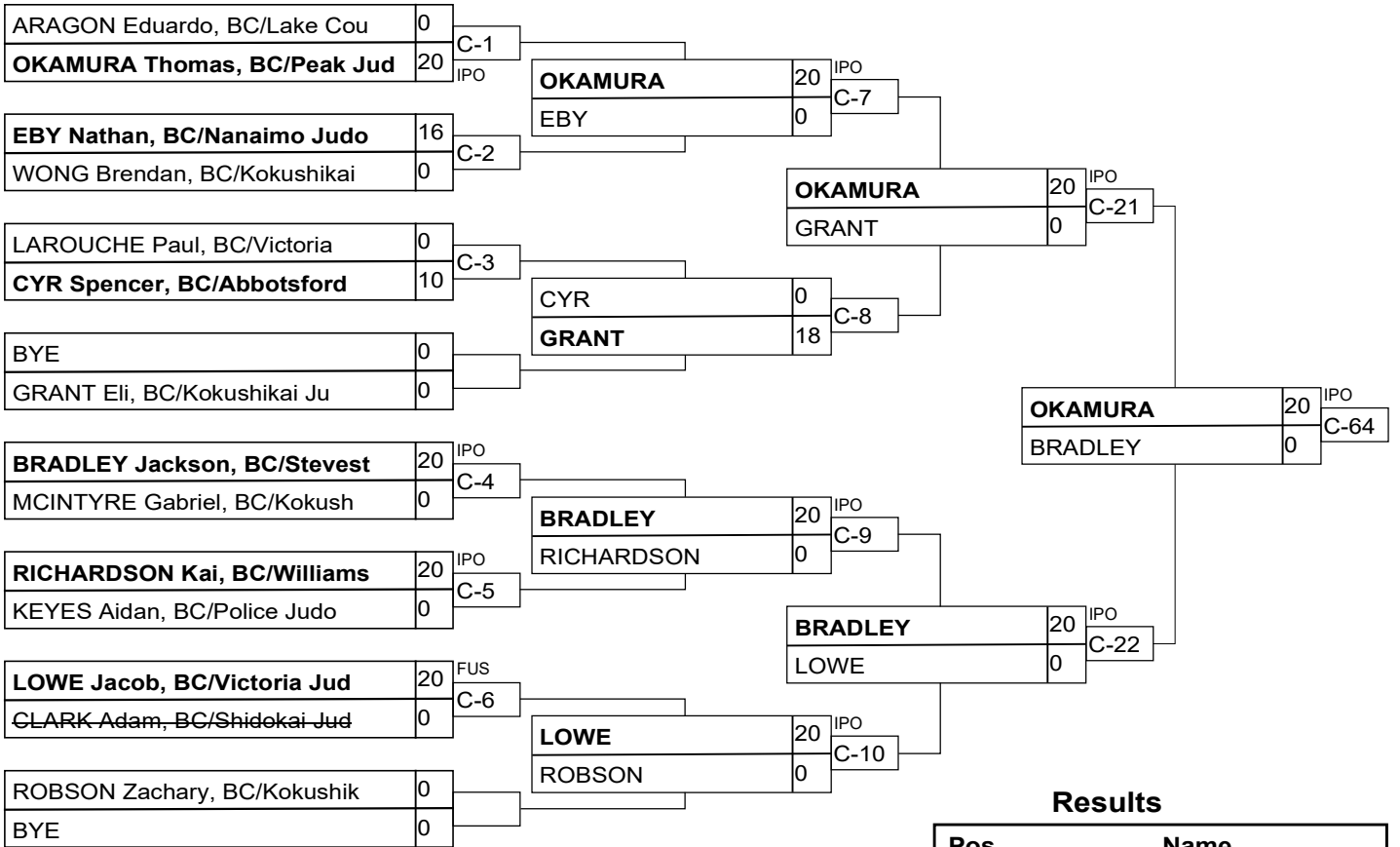

Results

Pos	Name
1	OKAMURA Thomas, BC/Peak
2	BRADLEY Jackson, BC/Stev
3	RICHARDSON Kai, BC/Willi
3	EBY Nathan, BC/Nanaimo J

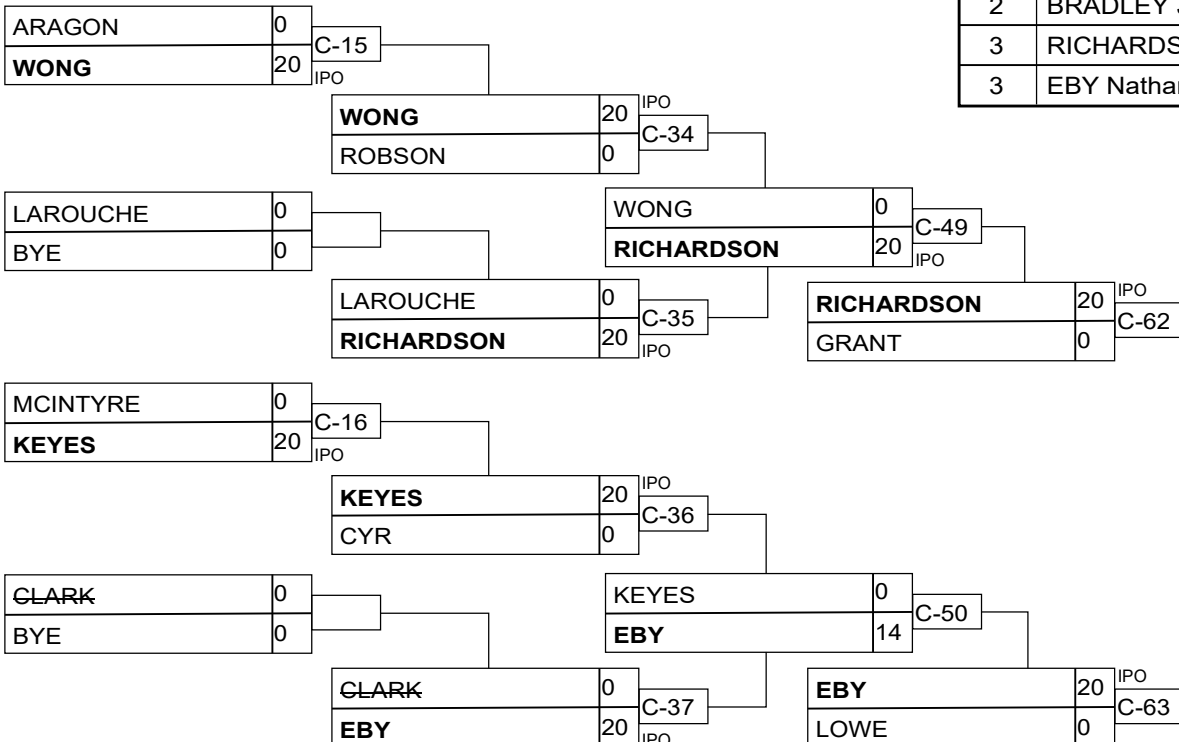

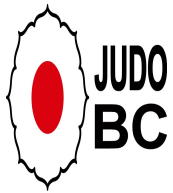

Senior Male NW Medium



Competitors

#	Name	Grade	Club	1	2	3	4	5	Wins	Pts	Pos
1	LYON Tim	Nidan	BC/Peak Judo Club	XX	20	20	20	20	4	80	1
2	HAUS Jack	Brown	BC/Steveston Judo Club		XX		20		1	20	4
3	KEIRSTEAD John	Shodan	BC/Shidokai Judo		14	XX	12		2	26	3
4	HARRIS Jordan	Brown	BC/Abbotsford Judo Club				XX		0	0	5
5	SMILEY Christopher	Nidan	BC/Lake Country Judo Clu		20	20	20	XX	3	60	2

Matches

Match	White	Blue	Result	Time	Code
C-13	HARRIS Jordan	4 5 SMILEY Christopher	2 - 20	0:53	IPO
C-14	LYON Tim	1 2 HAUS Jack	20 - 0	2:10	IPO
C-19	KEIRSTEAD John	3 4 HARRIS Jordan	12 - 0	4:00	
C-20	LYON Tim	1 5 SMILEY Christopher	20 - 2	4:42	GSI
C-27	HAUS Jack	2 3 KEIRSTEAD John	10 - 14	4:00	
C-28	LYON Tim	1 4 HARRIS Jordan	20 - 0	0:33	IPO
C-42	KEIRSTEAD John	3 5 SMILEY Christopher	0 - 20	0:49	IPO
C-43	HAUS Jack	2 4 HARRIS Jordan	20 - 0	0:31	IPO
C-55	LYON Tim	1 3 KEIRSTEAD John	20 - 0	2:07	IPO
C-56	HAUS Jack	2 5 SMILEY Christopher	0 - 20	0:55	IPO

Results

Pos	Name
1	LYON Tim, BC/Peak Judo Club
2	SMILEY Christopher, BC/Lake Country Judo Club
3	KEIRSTEAD John, BC/Shidokai Judo
4	HAUS Jack, BC/Steveston Judo Club

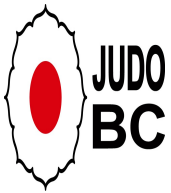

U14 Female -33kg



Competitors

#	Name	Grade	Club	1	2	3	4	Wins	Pts	Pos
1	KO Sarah	Yellow	BC/Peak Judo Club	XX				0	0	4
2	PARK Harper	Yellow	BC/Peak Judo Club	10	XX	10	10	3	30	1
3	WALSH Lily	Yellow	BC/Kokushikai Judo	10		XX		1	10	3
4	DAFOE Jordynn	Yellow	BC/Nanaimo Judo Club	10		10	XX	2	20	2

Matches

Match	White	Blue	Result	Time	Code
C-32	KO Sarah 1 2	PARK Harper	0 - 10	1:47	WIP
C-33	WALSH Lily 3 4	DAFOE Jordynn	0 - 10	0:45	WIP
C-47	KO Sarah 1 3	WALSH Lily	0 - 10	0:49	WIP
C-48	PARK Harper 2 4	DAFOE Jordynn	10 - 0	1:36	WIP
C-60	KO Sarah 1 4	DAFOE Jordynn	0 - 10	0:36	WIP
C-61	PARK Harper 2 3	WALSH Lily	10 - 0	2:18	WIP

Results

Pos	Name
1	PARK Harper, BC/Peak Judo Club
2	DAFOE Jordynn, BC/Nanaimo Judo Club
3	WALSH Lily, BC/Kokushikai Judo

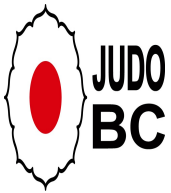

U14 Female -44kg



Competitors

#	Name	Grade	Club	1	2	3	Wins	Pts	Pos
1	AU Megan	Green	BC/Peak Judo Club	XX	10	10	2	20	1
2	YIN Abigail	Green	BC/Prince George Judo Cl		XX		0	0	3
3	FOSTERSON Trinity	Orange/Green	BC/Nanaimo Judo Club		10	XX	1	10	2

Matches

Match	White		Blue	Result	Time	Code
B-26	AU Megan	1	2 YIN Abigail	10 - 0	0:08	IPO
B-36	AU Megan	1	3 FOSTERSON Trinity	10 - 0	0:17	IPO
B-48	YIN Abigail	2	3 FOSTERSON Trinity	0 - 10	2:15	IPO

Results

Pos	Name
1	AU Megan, BC/Peak Judo Club
2	FOSTERSON Trinity, BC/Nanaimo Judo Club

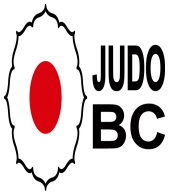

U14 Female -52kg



Competitors

#	Name	Grade	Club	1	2	1	2	1	2	Wins	Pts	Pos
1	BECKETT Olivia	Green	BC/Prince George Judo Cl	XX	10	XX		XX		1	10	2
2	KEIRSTEAD Wish	Blue	BC/Shidokai Judo		XX	10	XX	10	XX	2	20	1

Matches

Match	White			Blue	Result	Time	Code
B-23	BECKETT Olivia	1	2	KEIRSTEAD Wish	10 - 0	1:16	IPO
B-35	KEIRSTEAD Wish	2	1	BECKETT Olivia	10 - 0	0:33	IPO
B-45	BECKETT Olivia	1	2	KEIRSTEAD Wish	0 - 10	1:28	IPO

Results

Pos	Name
1	KEIRSTEAD Wish, BC/Shidokai Judo
2	BECKETT Olivia, BC/Prince George Judo Club

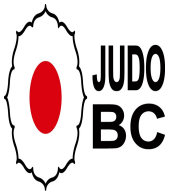

U14 Female +63kg



Competitors

#	Name	Grade	Club	1	2	1	2	1	2	Wins	Pts	Pos
1	PUSHKIN Aurora	Orange	BC/Steveston Judo Club	XX		XX		XX		0	0	2
2	MACDOUGALL Jaelyn	Orange/Green	BC/Abbotsford Judo Club	10	XX	10	XX		XX	2	20	1

Matches

Match	White			Blue	Result	Time	Code
C-30	PUSHKIN Aurora	1	2	MACDOUGALL Jaelyn	0 - 10	1:28	IPO
C-45	MACDOUGALL Jaelyn	2	1	PUSHKIN Aurora	10 - 0	1:18	WIP
C-58	PUSHKIN Aurora	1	2	MACDOUGALL Jaelyn			

Results

Pos	Name
1	MACDOUGALL Jaelyn, BC/Abbotsford Judo Club

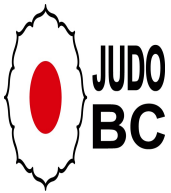

U14 Male -35kg



Competitors

#	Name	Grade	Club	1	2	3	4	Wins	Pts	Pos
1	WONG Lawren	Green	BC/Nakashima Dojo Judo C	XX	10	10		2	20	2
2	MARCK Michael	Orange	BC/Nanaimo Judo Club		XX			0	0	4
3	CARTWRIGHT Landen	Orange	BC/Prince George Judo Cl		10	XX		1	10	3
4	LE BRIS Ewen	Green	BC/Peak Judo Club	5	10	10	XX	3	25	1

Matches

Match	White	Blue	Result	Time	Code
C-23	WONG Lawren	1 2 MARCK Michael	10 - 0	1:17	IPO
C-24	CARTWRIGHT Landen	3 4 LE BRIS Ewen	0 - 10	0:31	IPO
C-38	WONG Lawren	1 3 CARTWRIGHT Landen	10 - 0	0:30	IPO
C-39	MARCK Michael	2 4 LE BRIS Ewen	0 - 10	0:34	IPO
C-51	WONG Lawren	1 4 LE BRIS Ewen	0 - 5	3:00	WAZ
C-52	MARCK Michael	2 3 CARTWRIGHT Landen	0 - 10	1:37	WIP

Results

Pos	Name
1	LE BRIS Ewen, BC/Peak Judo Club
2	WONG Lawren, BC/Nakashima Dojo Judo Club
3	CARTWRIGHT Landen, BC/Prince George Judo Club

U14 Male -42kg

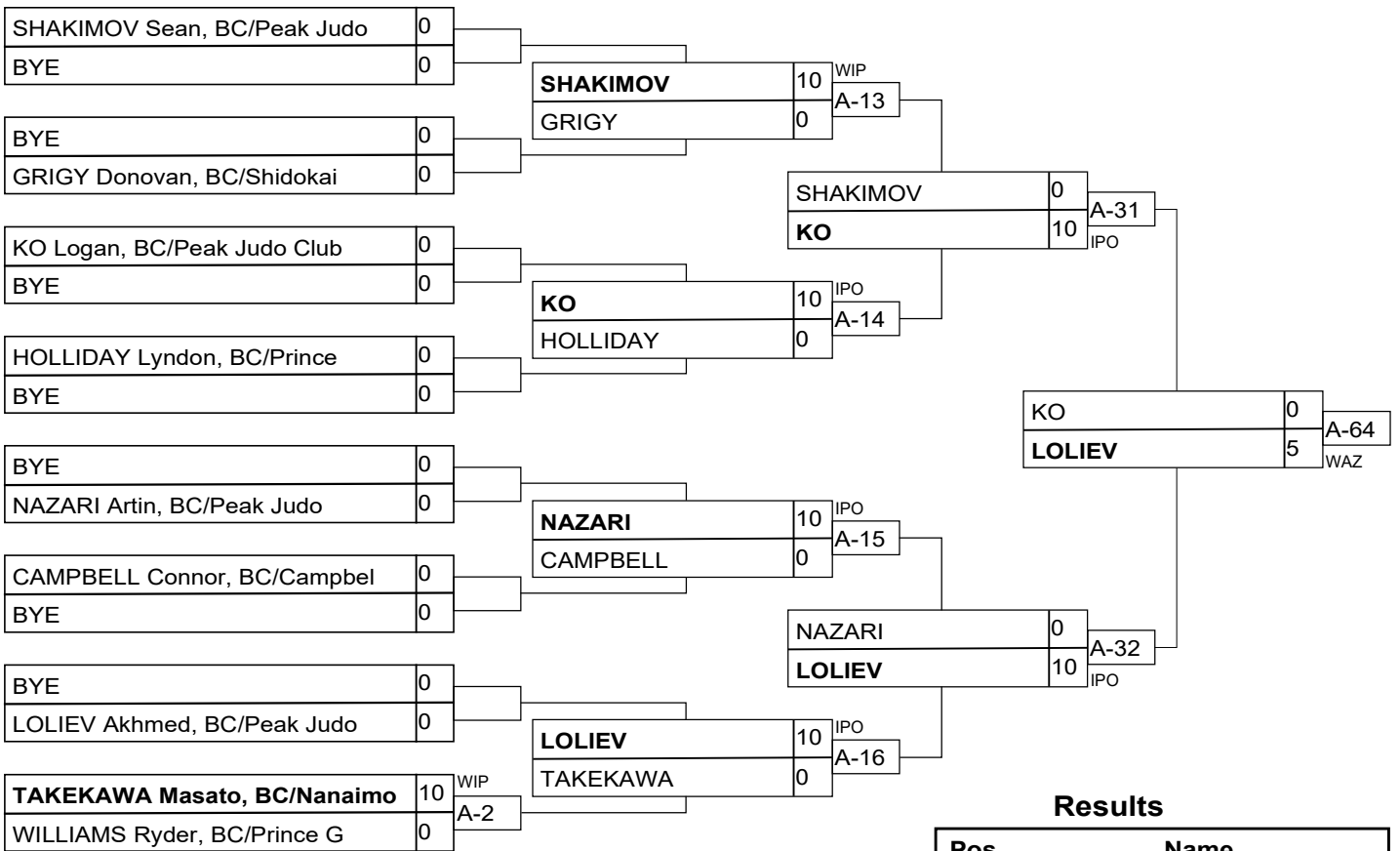

Results

Pos	Name
1	LOLIEV Akhmed, BC/Peak J
2	KO Logan, BC/Peak Judo C
3	TAKEKAWA Masato, BC/Nana
3	NAZARI Artin, BC/Peak Ju

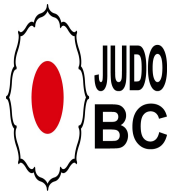

U14 Male -46kg



Competitors

#	Name	Grade	Club	1	2	3	4	5	Wins	Pts	Pos
1	TEMIRBAEV Amir	Green/Blue	BC/Peak Judo Club	XX	10	10	10	10	4	40	1
2	PARK Kingston	Yellow	BC/Peak Judo Club		XX	10		10	2	20	3
3	HEDSTROM Jesse-Castor	Green	BC/Prince George Judo Cl			XX		10	1	10	4
4	ARUTYUNYAN Eric	Green	BC/Steveston Judo Club		10	10	XX	10	3	30	2
5	FELGAR Micah	Orange	BC/Steveston Judo Club					XX	0	0	5

Matches

Match	White	Blue	Result	Time	Code
A-7	ARUTYUNYAN Eric	4 5 FELGAR Micah	10 - 0	1:52	IPO
A-8	TEMIRBAEV Amir	1 2 PARK Kingston	10 - 0	0:25	IPO
A-22	HEDSTROM Jesse-Castor	3 4 ARUTYUNYAN Eric	0 - 10	1:03	WIP
A-23	TEMIRBAEV Amir	1 5 FELGAR Micah	10 - 0	0:15	IPO
A-27	PARK Kingston	2 3 HEDSTROM Jesse-Castor	10 - 0	3:00	GSI
A-28	TEMIRBAEV Amir	1 4 ARUTYUNYAN Eric	10 - 0	0:30	WIP
A-37	HEDSTROM Jesse-Castor	3 5 FELGAR Micah	10 - 0	1:59	IPO
A-38	PARK Kingston	2 4 ARUTYUNYAN Eric	0 - 10	0:54	IPO
A-47	TEMIRBAEV Amir	1 3 HEDSTROM Jesse-Castor	10 - 0	0:32	IPO
A-48	PARK Kingston	2 5 FELGAR Micah	10 - 0	1:51	IPO

Results

Pos	Name
1	TEMIRBAEV Amir, BC/Peak Judo Club
2	ARUTYUNYAN Eric, BC/Steveston Judo Club
3	PARK Kingston, BC/Peak Judo Club
4	HEDSTROM Jesse-Castor, BC/Prince George Judo

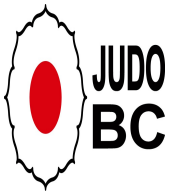

U14 Male -55kg



Competitors A

#	Name	Grade	Club	1	2	3	4	Wins	Pts	Pos
1	THOM Max	Yellow	BC/Police Judo Junior	XX			5	1	5	3
2	LUDLOW Elijah	Orange	BC/Shidokai Judo	10	XX	10	10	3	30	1
3	KIM Aiden	Orange	BC/Champion Judo Club	10		XX	10	2	20	2
4	ITO Taiyo	Orange/Green	BC/Steveston Judo Club				XX	0	0	4

Pool A

Match	White	Blue	Result	Time	Code
B-28	THOM Max	LUDLOW Elijah	0 - 10	2:03	WIP
B-29	KIM Aiden	ITO Taiyo	10 - 0	0:10	IPO
B-38	THOM Max	KIM Aiden	0 - 10	1:44	IPO
B-39	LUDLOW Elijah	ITO Taiyo	10 - 0	2:03	IPO
B-50	THOM Max	ITO Taiyo	5 - 0	3:00	WAZ
B-51	LUDLOW Elijah	KIM Aiden	10 - 0	0:38	IPO

Competitors B

#	Name	Grade	Club	5	6	7	Wins	Pts	Pos
5	CLARK James	Green	BC/Steveston Judo Club	XX		10	1	10	2
6	ROTBART Orion	Orange/Green	BC/Abbotsford Judo Club	10	XX	10	2	20	1
7	STEIGER Dawson	Green	BC/Prince George Judo Cl			XX	0	0	3

Pool B

Match	White	Blue	Result	Time	Code
B-30	CLARK James	ROTBART Orion	0 - 10	0:13	IPO
B-40	CLARK James	STEIGER Dawson	10 - 0	0:35	IPO
B-52	ROTBART Orion	STEIGER Dawson	10 - 0	0:13	IPO

LUDLOW

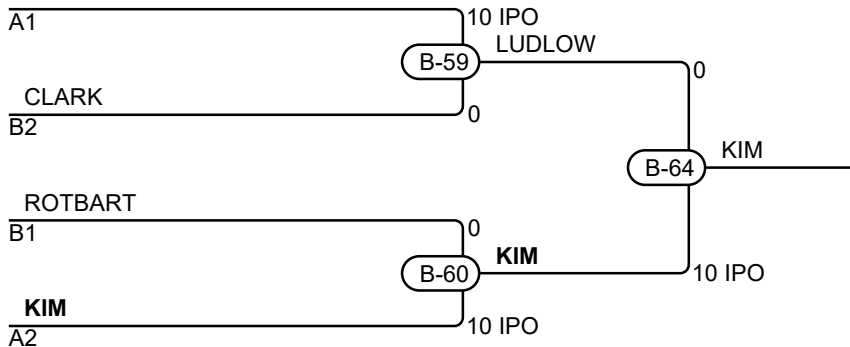

Results

Pos	Name
1	KIM Aiden, BC/Champion Judo Club
2	LUDLOW Elijah, BC/Shidokai Judo
3	CLARK James, BC/Steveston Judo Club
3	ROTBART Orion, BC/Abbotsford Judo Club

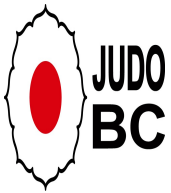

U16 Female -44kg



Competitors

#	Name	Grade	Club	1	2	3	Wins	Pts	Pos
1	ANTOSH Megan	Green	BC/Port Coquitlam Judo C	XX	10		1	10	2
2	KEIRSTEAD Wish	Blue	BC/Shidokai Judo		XX		0	0	3
3	AU Megan	Green	BC/Peak Judo Club	10	10	XX	2	20	1

Matches

Match	White		Blue	Result	Time	Code	
C-19	ANTOSH Megan	1	2	KEIRSTEAD Wish	10 - 0	2:45	WIP
C-50	ANTOSH Megan	1	3	AU Megan	0 - 10	0:20	IPO
C-56	KEIRSTEAD Wish	2	3	AU Megan	0 - 10	1:43	IPO

Results

Pos	Name
1	AU Megan, BC/Peak Judo Club
2	ANTOSH Megan, BC/Port Coquitlam Judo Club

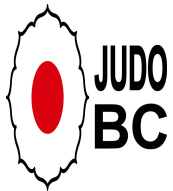

U16 Female -48kg



Competitors

#	Name	Grade	Club	1	2	3	4	Wins	Pts	Pos
1	MA Julie	Orange	BC/Peak Judo Club	XX				0	0	4
2	WHITTLE Gwen	Green	BC/Campbell River Judo C	10	XX	10	10	3	30	1
3	BOULDING Clare	Green/Blue	BC/Nanaimo Judo Club	10		XX	10	2	20	2
4	GILCHRIST Lily	Orange	BC/Westside Judo	10			XX	1	10	3

Matches

Match	White			Blue	Result	Time	Code
A-23	MA Julie	1	2	WHITTLE Gwen	0 - 10	0:36	WIP
A-24	BOULDING Clare	3	4	GILCHRIST Lily	10 - 0	0:18	IPO
A-33	MA Julie	1	3	BOULDING Clare	0 - 10	0:16	IPO
A-34	WHITTLE Gwen	2	4	GILCHRIST Lily	10 - 0	0:16	IPO
A-45	MA Julie	1	4	GILCHRIST Lily	0 - 10	1:53	IPO
A-47	WHITTLE Gwen	2	3	BOULDING Clare	10 - 0	0:26	IPO

Results

Pos	Name
1	WHITTLE Gwen, BC/Campbell River Judo Club
2	BOULDING Clare, BC/Nanaimo Judo Club
3	GILCHRIST Lily, BC/Westside Judo

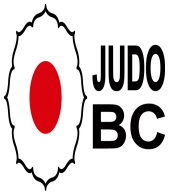

U16 Female -52kg



Competitors A

#	Name	Grade	Club	1	2	3	Wins	Pts	Pos
1	KO Jenna	Blue	BC/Peak Judo Club	XX	10	10	2	20	1
2	MCRORY Jordyn	Blue	BC/Kelowna Judo Club		XX	10	1	10	2
3	CONNOLLY Claire	Orange	BC/Westsyde Judo			XX	0	0	3

Pool A

Match	White	Blue	Result	Time	Code
A-25	KO Jenna	1 2 MCRORY Jordyn	10 - 0	1:41	WIP
A-38	KO Jenna	1 3 CONNOLLY Claire	10 - 0	0:49	WIP
A-44	MCRORY Jordyn	2 3 CONNOLLY Claire	10 - 0	3:00	IPO

Competitors B

#	Name	Grade	Club	4	5	6	Wins	Pts	Pos
4	VELONAS Athena	Blue	BC/Abbotsford Judo Club	XX		5	1	5	2
5	JONES Nevada	Blue	BC/Prince George Judo Cl	10	XX	10	2	20	1
6	HINCHEY Lia	Green	YT/Shiroumakai			XX	0	0	3

Pool B

Match	White	Blue	Result	Time	Code
A-26	VELONAS Athena	4 5 JONES Nevada	0 - 10	1:43	IPO
A-39	VELONAS Athena	4 6 HINCHEY Lia	5 - 0	3:00	WAZ
A-46	JONES Nevada	5 6 HINCHEY Lia	10 - 0	1:31	IPO

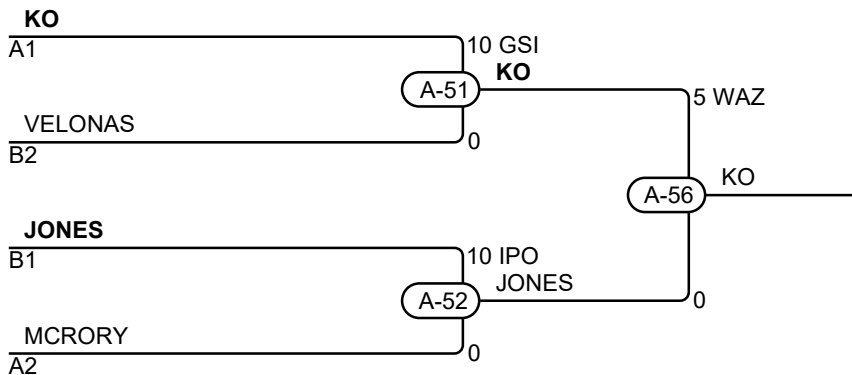

Results

Pos	Name
1	KO Jenna, BC/Peak Judo Club
2	JONES Nevada, BC/Prince George Judo Club
3	VELONAS Athena, BC/Abbotsford Judo Club
3	MCRORY Jordyn, BC/Kelowna Judo Club

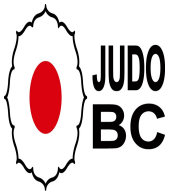

U16 Female -57kg



Competitors A

#	Name	Grade	Club	1	2	3	Wins	Pts	Pos
1	HANN Bridgette	Orange	BC/Nanaimo Judo Club	XX			0	0	3
2	MICHALUK Annika	Blue	BC/Shidokai Judo	10	XX	10	2	20	1
3	MACLEOD Hailey	Green	BC/Campbell River Judo C	10		XX	1	10	2

Pool A

Match	White	Blue	Result	Time	Code
C-11	HANN Bridgette	1 2 MICHALUK Annika	0 - 10	0:19	WIP
C-20	HANN Bridgette	1 3 MACLEOD Hailey	0 - 10	0:51	WIP
C-36	MICHALUK Annika	2 3 MACLEOD Hailey	10 - 0	2:30	HAN

Competitors B

#	Name	Grade	Club	4	5	6	Wins	Pts	Pos
4	HINCHEY Jaymi	Green	YT/Shiroumakai	XX	10	10	2	20	1
5	VIEAUX Sayjah	Blue	BC/Nanaimo Judo Club		XX	10	1	10	2
6	KUNADZE Maya	Blue	BC/Kokushikai Judo			XX	0	0	3

Pool B

Match	White	Blue	Result	Time	Code
C-12	HINCHEY Jaymi	4 5 VIEAUX Sayjah	10 - 0	1:08	WIP
C-21	HINCHEY Jaymi	4 6 KUNADZE Maya	10 - 0	1:30	IPO
C-37	VIEAUX Sayjah	5 6 KUNADZE Maya	10 - 0	0:00	KIK

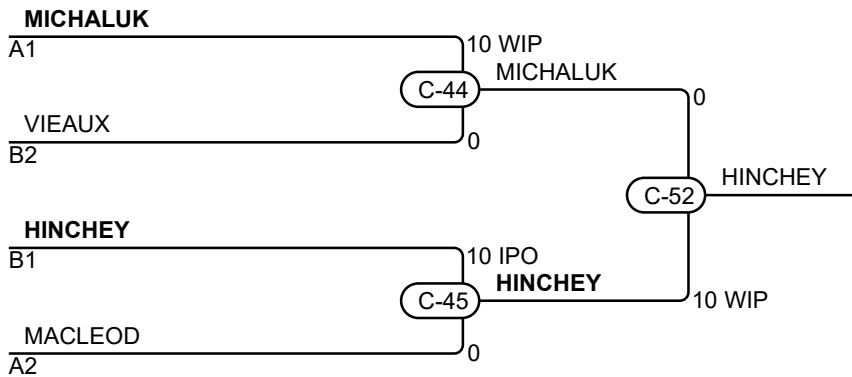

Results

Pos	Name
1	HINCHEY Jaymi, YT/Shiroumakai
2	MICHALUK Annika, BC/Shidokai Judo
3	VIEAUX Sayjah, BC/Nanaimo Judo Club
3	MACLEOD Hailey, BC/Campbell River Judo Club

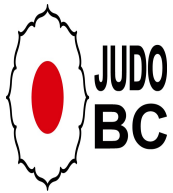

U16 Female -70kg



Competitors

#	Name	Grade	Club	1	2	3	4	5	Wins	Pts	Pos
1	MCCULLOUGH Lily	Blue	BC/Prince George Judo Cl	XX	10	10	10	10	4	40	1
2	SZASZ Kipling	Green/Blue	BC/Nanaimo Judo Club		XX	10	5	10	3	25	2
3	MCLEAN Leah	Orange	YT/Shiroumakai			XX			0	0	5
4	YIN Hannah	Blue	BC/Prince George Judo Cl			10	XX		1	10	4
5	STEIGER Alandra	Blue	BC/Prince George Judo Cl			10	10	XX	2	20	3

Matches

Match	White	Blue	Result	Time	Code
B-17	YIN Hannah	4 5 STEIGER Alandra	0 - 10	2:29	IPO
B-18	MCCULLOUGH Lily	1 2 SZASZ Kipling	10 - 0	2:28	IPO
B-21	MCLEAN Leah	3 4 YIN Hannah	0 - 10	1:23	IPO
B-29	MCCULLOUGH Lily	1 5 STEIGER Alandra	10 - 0	3:00	IPO
B-30	SZASZ Kipling	2 3 MCLEAN Leah	10 - 0	0:34	WIP
B-31	MCCULLOUGH Lily	1 4 YIN Hannah	10 - 0	1:01	WIP
B-40	MCLEAN Leah	3 5 STEIGER Alandra	0 - 10	1:46	IPO
B-41	SZASZ Kipling	2 4 YIN Hannah	5 - 0	3:00	WAZ
B-42	MCCULLOUGH Lily	1 3 MCLEAN Leah	10 - 0	0:26	IPO
B-47	SZASZ Kipling	2 5 STEIGER Alandra	10 - 0	1:52	WIP

Results

Pos	Name
1	MCCULLOUGH Lily, BC/Prince George Judo Club
2	SZASZ Kipling, BC/Nanaimo Judo Club
3	STEIGER Alandra, BC/Prince George Judo Club
4	YIN Hannah, BC/Prince George Judo Club

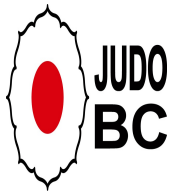

U16 Male -38kg



Competitors

#	Name	Grade	Club	1	2	3	4	5	Wins	Pts	Pos
1	LOLIEV Akhmed	Green/Blue	BC/Peak Judo Club	XX	10	10	10	10	4	40	1
2	WONG Lawren	Green	BC/Nakashima Dojo Judo C		XX		10	10	2	20	3
3	HILLMAN Jackson	Green	BC/Abbotsford Judo Club		5	XX	10	10	3	25	2
4	CAMPBELL Connor	Orange	BC/Campbell River Judo C				XX		0	0	5
5	SIAH Kalil	Orange	BC/Campbell River Judo C				5	XX	1	5	4

Matches

Match	White	Blue	Result	Time	Code
C-15	CAMPBELL Connor	4 5 SIAH Kalil	0 - 5	3:00	WAZ
C-16	LOLIEV Akhmed	1 2 WONG Lawren	10 - 0	1:52	IPO
C-32	HILLMAN Jackson	3 4 CAMPBELL Connor	10 - 0	1:39	WIP
C-33	LOLIEV Akhmed	1 5 SIAH Kalil	10 - 0	1:34	WIP
C-38	WONG Lawren	2 3 HILLMAN Jackson	0 - 5	4:18	GSW
C-41	LOLIEV Akhmed	1 4 CAMPBELL Connor	10 - 0	0:32	IPO
C-43	HILLMAN Jackson	3 5 SIAH Kalil	10 - 0	1:23	IPO
C-46	WONG Lawren	2 4 CAMPBELL Connor	10 - 0	1:14	IPO
C-48	LOLIEV Akhmed	1 3 HILLMAN Jackson	10 - 0	0:58	WIP
C-53	WONG Lawren	2 5 SIAH Kalil	10 - 0	1:24	IPO

Results

Pos	Name
1	LOLIEV Akhmed, BC/Peak Judo Club
2	HILLMAN Jackson, BC/Abbotsford Judo Club
3	WONG Lawren, BC/Nakashima Dojo Judo Club
4	SIAH Kalil, BC/Campbell River Judo Club

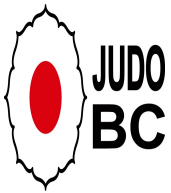

U16 Male -42kg



Competitors

#	Name	Grade	Club	1	2	3	4	Wins	Pts	Pos
1	KO Logan	Green	BC/Peak Judo Club	XX	10	10		2	20	2
2	NAZARI Artin	Green	BC/Peak Judo Club		XX	10	5	2	15	3
3	TAKEKAWA Masato	Orange/Green	BC/Nanaimo Judo Club			XX		0	0	4
4	HINTON Tobin	Green/Blue	BC/Police Judo Junior	10		10	XX	2	20	1

Matches

Match	White	Blue	Result	Time	Code
C-17	KO Logan	1 2 NAZARI Artin	10 - 0	2:53	IPO
C-18	TAKEKAWA Masato	3 4 HINTON Tobin	0 - 10	0:31	IPO
C-47	KO Logan	1 3 TAKEKAWA Masato	10 - 0	0:25	IPO
C-49	NAZARI Artin	2 4 HINTON Tobin	5 - 0	3:00	WAZ
C-54	KO Logan	1 4 HINTON Tobin	0 - 10	0:48	WIP
C-55	NAZARI Artin	2 3 TAKEKAWA Masato	10 - 0	2:49	WIP

Results

Pos	Name
1	HINTON Tobin, BC/Police Judo Junior
2	KO Logan, BC/Peak Judo Club
3	NAZARI Artin, BC/Peak Judo Club

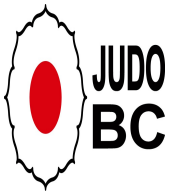

U16 Male -50kg



Competitors A

#	Name	Grade	Club	1	2	3	Wins	Pts	Pos
1	CHOW Timmy	Orange	BC/Steveston Judo Club	XX			0	0	3
2	CLARK James	Green	BC/Steveston Judo Club	10	XX		1	10	2
3	TEMIRBAEV Amir	Green/Blue	BC/Peak Judo Club	10	10	XX	2	20	1

Pool A

Match	White	Blue	Result	Time	Code
B-4	CHOW Timmy	1 2 CLARK James	0 - 10	0:50	IPO
B-22	CHOW Timmy	1 3 TEMIRBAEV Amir	0 - 10	1:03	IPO
B-32	CLARK James	2 3 TEMIRBAEV Amir	0 - 10	0:28	IPO

Competitors B

#	Name	Grade	Club	4	5	6	Wins	Pts	Pos
4	ITO Taiyo	Orange/Green	BC/Steveston Judo Club	XX			0	0	3
5	CARTWRIGHT Levi	Blue	BC/Prince George Judo Club	10	XX		1	10	2
6	MOES Ezekiel	Green/Blue	BC/Nanaimo Judo Club	10	10	XX	2	20	1

Pool B

Match	White	Blue	Result	Time	Code
B-5	ITO Taiyo	4 5 CARTWRIGHT Levi	0 - 10	0:30	IPO
B-23	ITO Taiyo	4 6 MOES Ezekiel	0 - 10	0:09	IPO
B-35	CARTWRIGHT Levi	5 6 MOES Ezekiel	0 - 10	0:19	IPO

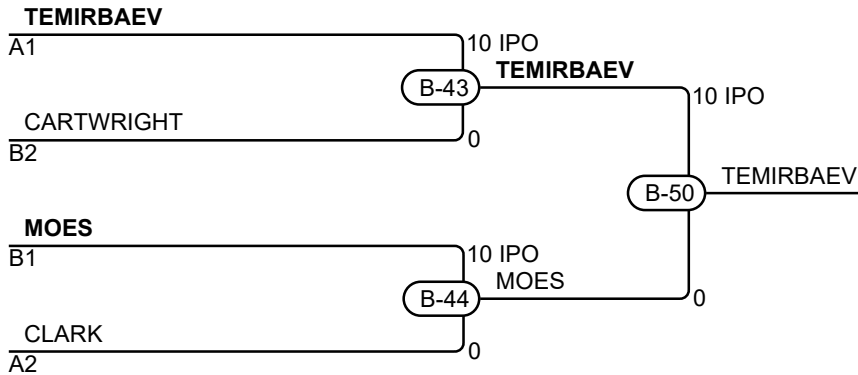

Results

Pos	Name
1	TEMIRBAEV Amir, BC/Peak Judo Club
2	MOES Ezekiel, BC/Nanaimo Judo Club
3	CARTWRIGHT Levi, BC/Prince George Judo Club
3	CLARK James, BC/Steveston Judo Club

U16 Male -55kg

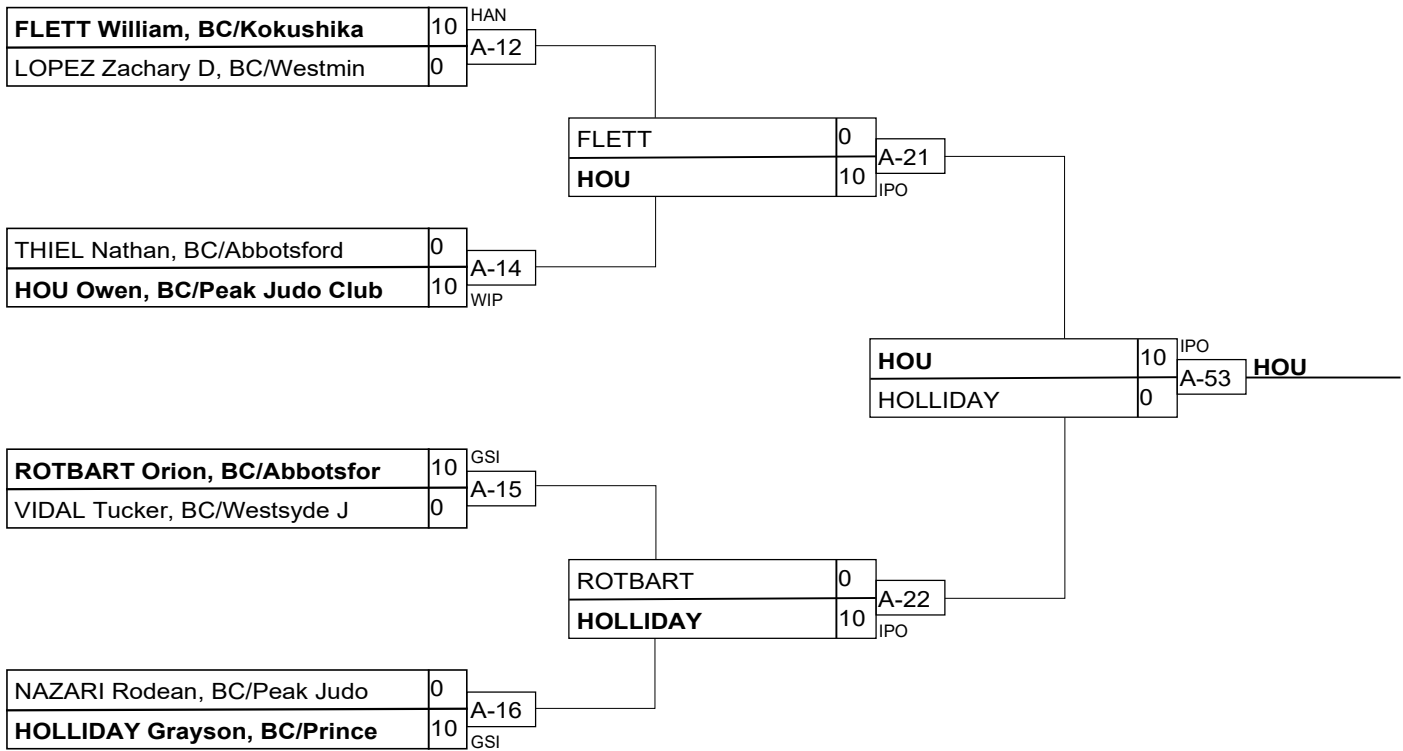

Results

Pos	Name
1	HOU Owen, BC/Peak Judo C
2	HOLLIDAY Grayson, BC/Pri
3	FLETT William, BC/Kokush
3	THIEL Nathan, BC/Abbotsf

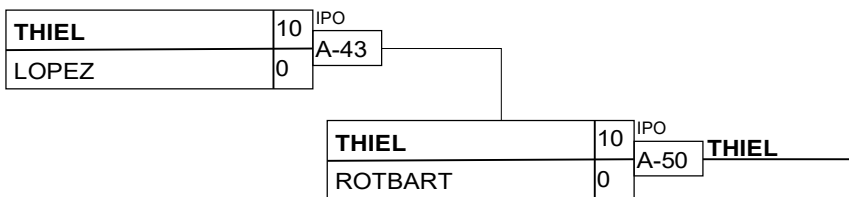
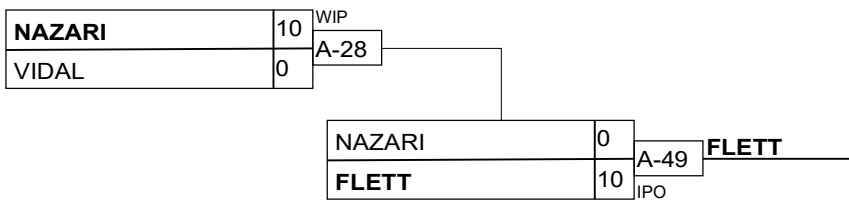

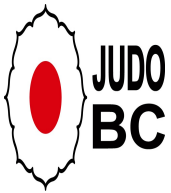

U16 Male -60kg



Competitors A

#	Name	Grade	Club	1	2	3	4	Wins	Pts	Pos
1	OVAKIM Rentaro	Green	BC/Kokushikai Judo	XX				0	0	4
2	MILEY Sawyer	Green	BC/Abbotsford Judo Club	10	XX		10	2	20	2
3	LE BRIS Lowan	Blue	BC/Peak Judo Club	10	10	XX	10	3	30	1
4	ANDREASSEN Soren	Green/Blue	BC/Abbotsford Judo Club	10			XX	1	10	3

Pool A

Match	White	Blue	Result	Time	Code
B-10	OVAKIM Rentaro	1 2 MILEY Sawyer	0 - 10	1:32	IPO
B-12	LE BRIS Lowan	3 4 ANDREASSEN Soren	10 - 0	0:12	IPO
B-26	OVAKIM Rentaro	1 3 LE BRIS Lowan	0 - 10	0:00	IPO
B-27	MILEY Sawyer	2 4 ANDREASSEN Soren	10 - 0	1:47	IPO
B-37	OVAKIM Rentaro	1 4 ANDREASSEN Soren	0 - 10	0:00	FUS
B-38	MILEY Sawyer	2 3 LE BRIS Lowan	0 - 10	0:56	IPO

Competitors B

#	Name	Grade	Club	5	6	7	Wins	Pts	Pos
5	DERKSEN Connor	Orange/Green	BC/Abbotsford Judo Club	XX	10		1	10	2
6	MEISTERMAN Kameron	Green	BC/Steveston Judo Club		XX		0	0	3
7	MEJIA KASAP Romario	Green	BC/Police Judo Junior	10	5	XX	2	15	1

Pool B

Match	White	Blue	Result	Time	Code
B-16	DERKSEN Connor	5 6 MEISTERMAN Kameron	10 - 0	1:15	WIP
B-28	DERKSEN Connor	5 7 MEJIA KASAP Romario	0 - 10	3:47	GSI
B-39	MEISTERMAN Kameron	6 7 MEJIA KASAP Romario	0 - 5	4:00	WAZ

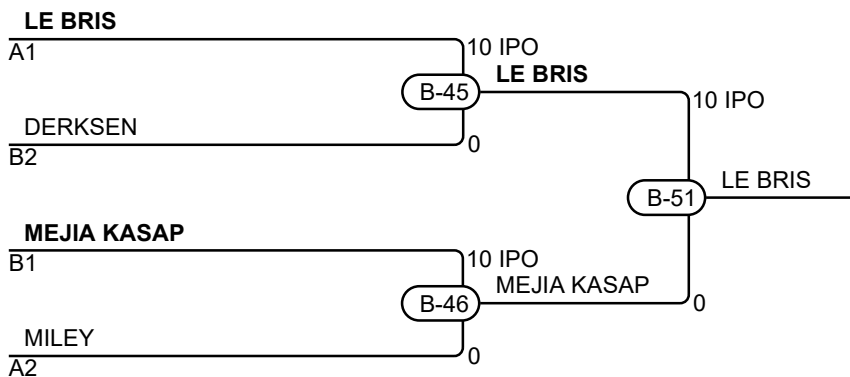

Results

Pos	Name
1	LE BRIS Lowan, BC/Peak Judo Club
2	MEJIA KASAP Romario, BC/Police Judo Junior
3	DERKSEN Connor, BC/Abbotsford Judo Club
3	MILEY Sawyer, BC/Abbotsford Judo Club

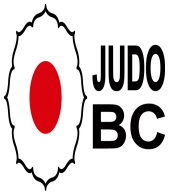

U16 Male -66kg



Competitors

#	Name	Grade	Club	1	2	3	Wins	Pts	Pos
1	HARRIS Zachary	Brown	BC/Abbotsford Judo Club	XX	10	10	2	20	1
2	KRUGER John	Green/Blue	BC/Nanaimo Judo Club		XX		0	0	3
3	DREYER Tuja	Orange/Green	BC/Kelowna Judo Club		10	XX	1	10	2

Matches

Match	White	Blue	Result	Time	Code
A-27	HARRIS Zachary	1 2 KRUGER John	10 - 0	0:14	IPO
A-40	HARRIS Zachary	1 3 DREYER Tuja	10 - 0	0:33	IPO
A-48	KRUGER John	2 3 DREYER Tuja	0 - 10	5:37	HAN

Results

Pos	Name
1	HARRIS Zachary, BC/Abbotsford Judo Club
2	DREYER Tuja, BC/Kelowna Judo Club

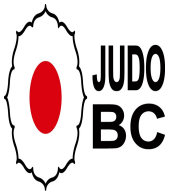

U16 Male +73kg



Competitors

#	Name	Grade	Club	1	2	3	Wins	Pts	Pos
1	CONNOLLY Liam	Green	BC/Westsyde Judo	XX			0	0	3
2	YUN Matthew	Blue	BC/Champion Judo Club	10	XX		1	10	2
3	WHITMORE Gavin	Blue	BC/Abbotsford Judo Club	10	10	XX	2	20	1

Matches

Match	White		Blue	Result	Time	Code
B-9	CONNOLLY Liam	1	2 YUN Matthew	0 - 10	0:12	IPO
B-24	CONNOLLY Liam	1	3 WHITMORE Gavin	0 - 10	2:53	WIP
B-36	YUN Matthew	2	3 WHITMORE Gavin	0 - 10	3:00	IPO

Results

Pos	Name
1	WHITMORE Gavin, BC/Abbotsford Judo Club
2	YUN Matthew, BC/Champion Judo Club

U18 Female -52kg

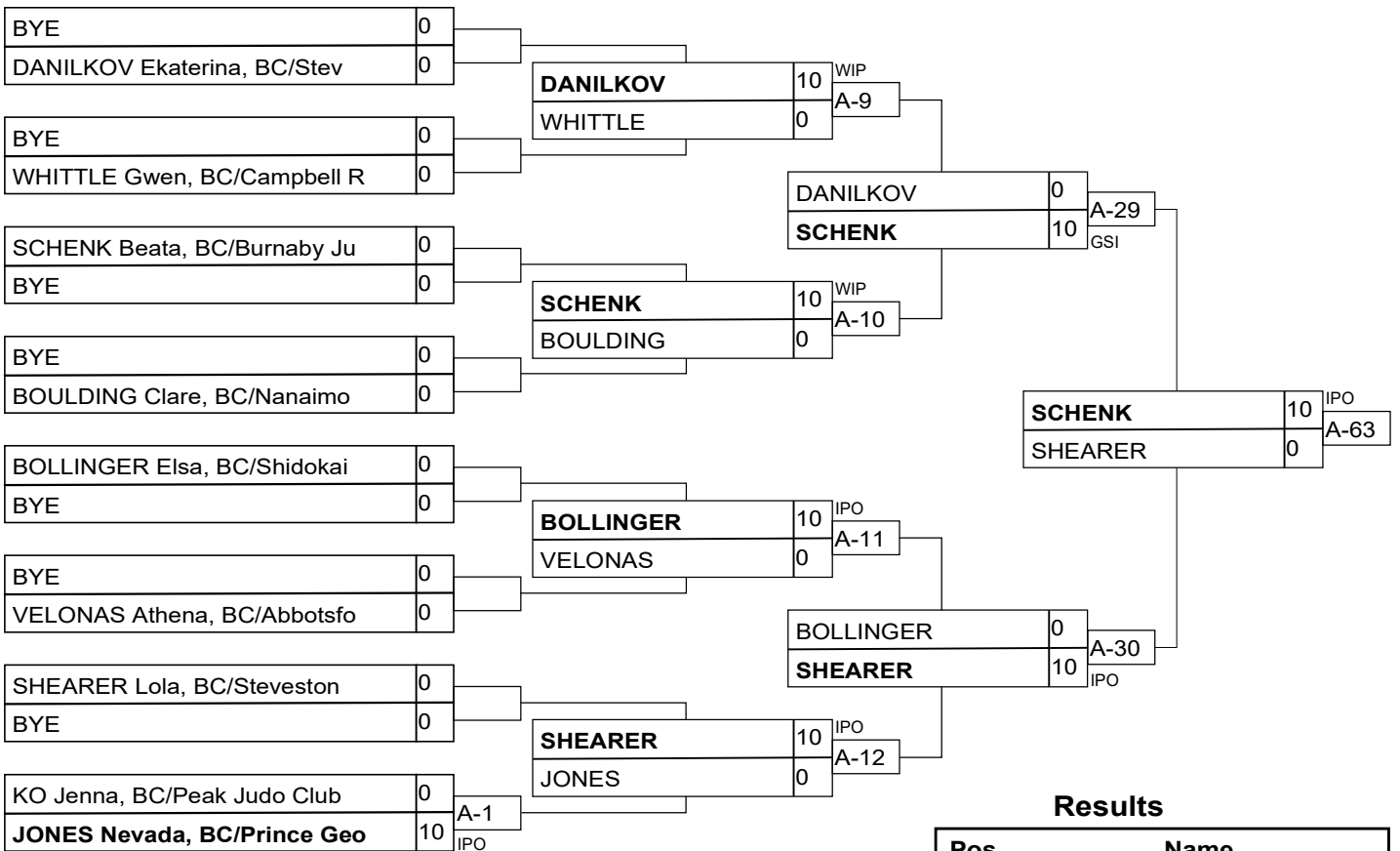

Results

Pos	Name
1	SCHENK Beata, BC/Burnaby
2	SHEARER Lola, BC/Stevest
3	JONES Nevada, BC/Prince
3	WHITTLE Gwen, BC/Campbel

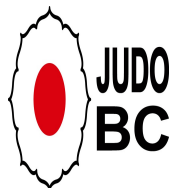

U18 Female -57kg



Competitors

#	Name	Grade	Club	1	2	3	4	5	Wins	Pts	Pos
1	ZHANG Liwen	Brown	BC/Police Judo Junior	XX	10	10	10	10	4	40	1
2	MACLEOD Hailey	Orange	BC/Campbell River Judo C		XX				0	0	5
3	KUNADZE Maya	Blue	BC/Kokushikai Judo		10	XX	10	10	3	30	2
4	VIEAUX Sayjah	Blue	BC/Nanaimo Judo Club		10		XX		1	10	4
5	MICHALUK Annika	Blue	BC/Shidokai Judo		10		10	XX	2	20	3

Matches

Match	White	Blue	Result	Time	Code
A-20	VIEAUX Sayjah	4 5 MICHALUK Annika	0 - 10	1:44	IPO
A-21	ZHANG Liwen	1 2 MACLEOD Hailey	10 - 0	0:46	IPO
A-25	KUNADZE Maya	3 4 VIEAUX Sayjah	10 - 0	3:57	IPO
A-26	ZHANG Liwen	1 5 MICHALUK Annika	10 - 0	2:04	IPO
A-35	MACLEOD Hailey	2 3 KUNADZE Maya	0 - 10	0:20	IPO
A-36	ZHANG Liwen	1 4 VIEAUX Sayjah	10 - 0	0:18	IPO
A-45	KUNADZE Maya	3 5 MICHALUK Annika	10 - 0	2:37	WIP
A-46	MACLEOD Hailey	2 4 VIEAUX Sayjah	0 - 10	1:32	IPO
A-55	ZHANG Liwen	1 3 KUNADZE Maya	10 - 0	2:24	WIP
A-56	MACLEOD Hailey	2 5 MICHALUK Annika	0 - 10	0:25	WIP

Results

Pos	Name
1	ZHANG Liwen, BC/Police Judo Junior
2	KUNADZE Maya, BC/Kokushikai Judo
3	MICHALUK Annika, BC/Shidokai Judo
4	VIEAUX Sayjah, BC/Nanaimo Judo Club

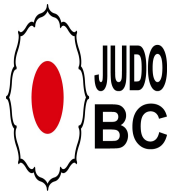

U18 Female -63kg



Competitors

#	Name	Grade	Club	1	2	3	Wins	Pts	Pos
1	STEIGER Alandra	Blue	BC/Prince George Judo Cl	XX			0	0	3
2	YIN Hannah	Blue	BC/Prince George Judo Cl	5	XX		1	5	2
3	SZASZ Kipling	Green/Blue	BC/Nanaimo Judo Club	10	10	XX	2	20	1

Matches

Match	White			Blue	Result	Time	Code
C-31	STEIGER Alandra	1	2	YIN Hannah	0 - 5	4:00	WAZ
C-46	STEIGER Alandra	1	3	SZASZ Kipling	0 - 10	4:09	HAN
C-59	YIN Hannah	2	3	SZASZ Kipling	0 - 10	1:50	WIP

Results

Pos	Name
1	SZASZ Kipling, BC/Nanaimo Judo Club
2	YIN Hannah, BC/Prince George Judo Club

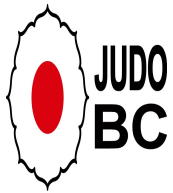

U18 Female -70kg



Competitors

#	Name	Grade	Club	1	2	3	Wins	Pts	Pos
1	MCCULLOUGH Lily	Blue	BC/Prince George Judo Cl	XX			0	0	3
2	ROTBART Nova	Brown	BC/Abbotsford Judo Club	5	XX		1	5	2
3	MORISHO Nyota	Shodan	BC/Kokushikai Judo	10	10	XX	2	20	1

Matches

Match	White	Blue	Result	Time	Code
B-27	MCCULLOUGH Lily	1 2 ROTBART Nova	0 - 5	4:00	WAZ
B-37	MCCULLOUGH Lily	1 3 MORISHO Nyota	0 - 10	0:15	IPO
B-49	ROTBART Nova	2 3 MORISHO Nyota	0 - 10	0:00	IPO

Results

Pos	Name
1	MORISHO Nyota, BC/Kokushikai Judo
2	ROTBART Nova, BC/Abbotsford Judo Club

U18 Male -55kg

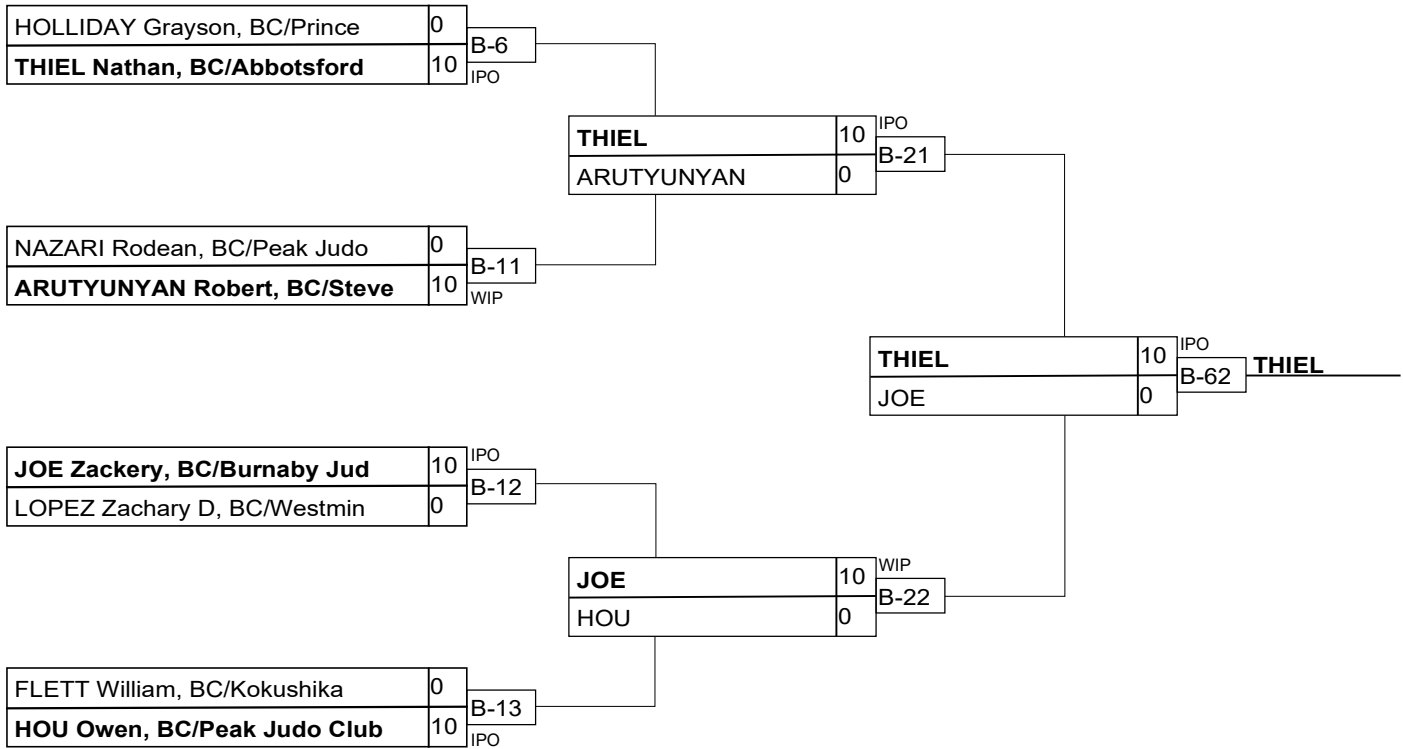

Results

Pos	Name
1	THIEL Nathan, BC/Abbotsf
2	JOE Zackery, BC/Burnaby
3	ARUTYUNYAN Robert, BC/St
3	HOLLIDAY Grayson, BC/Pri

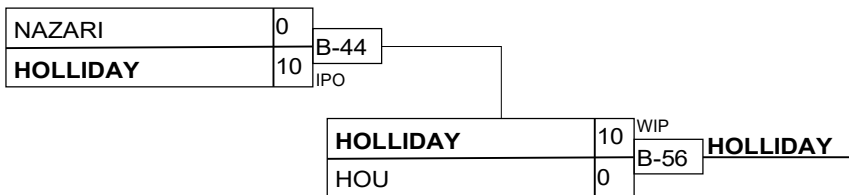
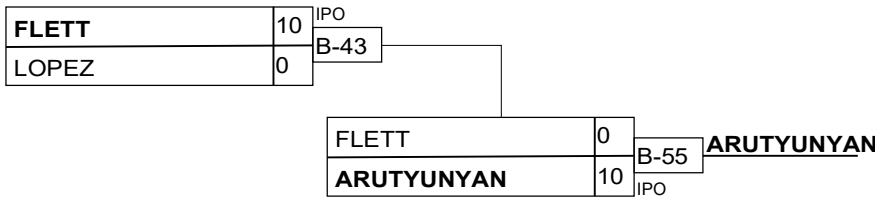

U18 Male -60kg

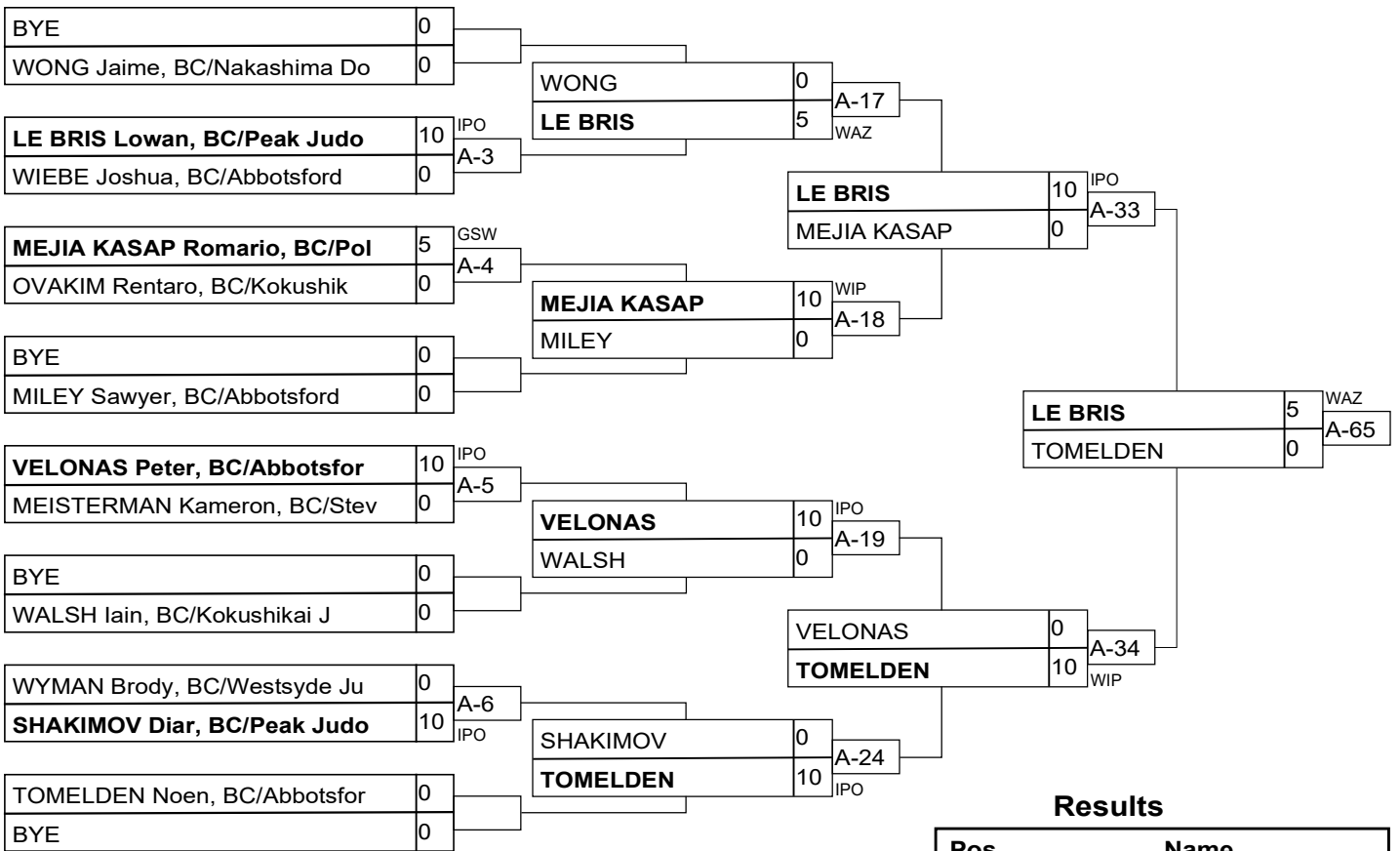

Results

Pos	Name
1	LE BRIS Lowan, BC/Peak J
2	TOMELDEN Noen, BC/Abbots
3	SHAKIMOV Diar, BC/Peak J
3	VELONAS Peter, BC/Abbots

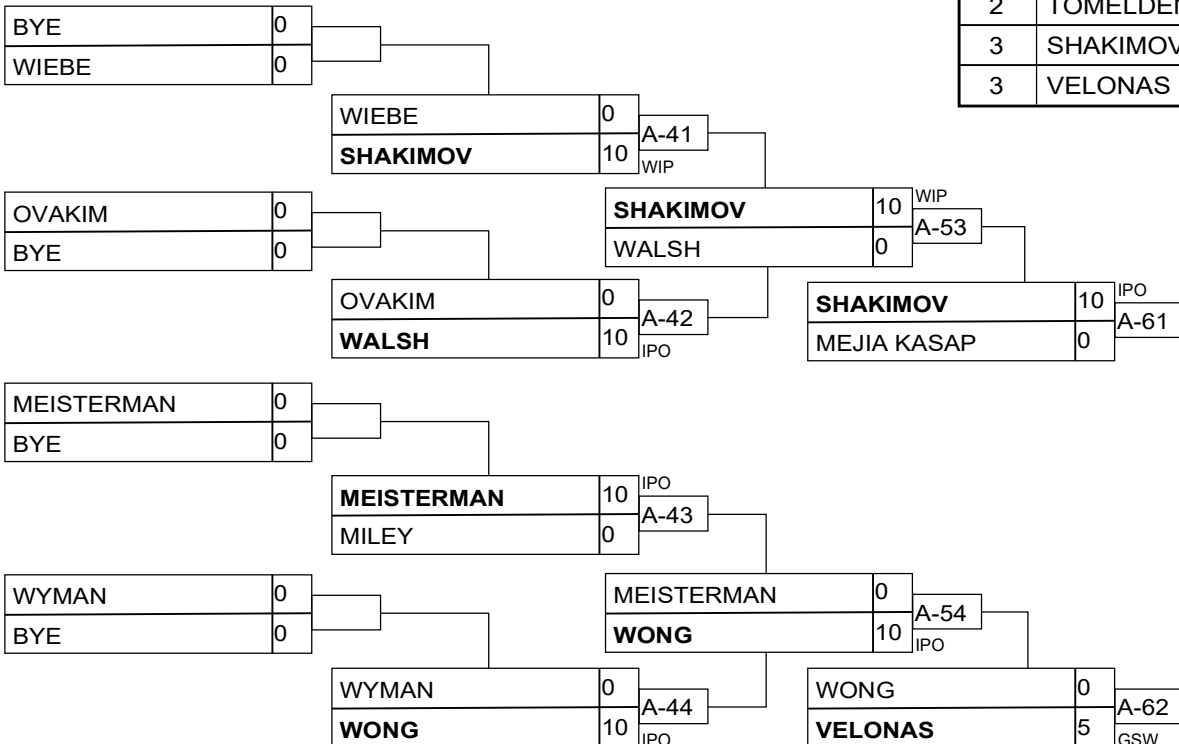

U18 Male -66kg

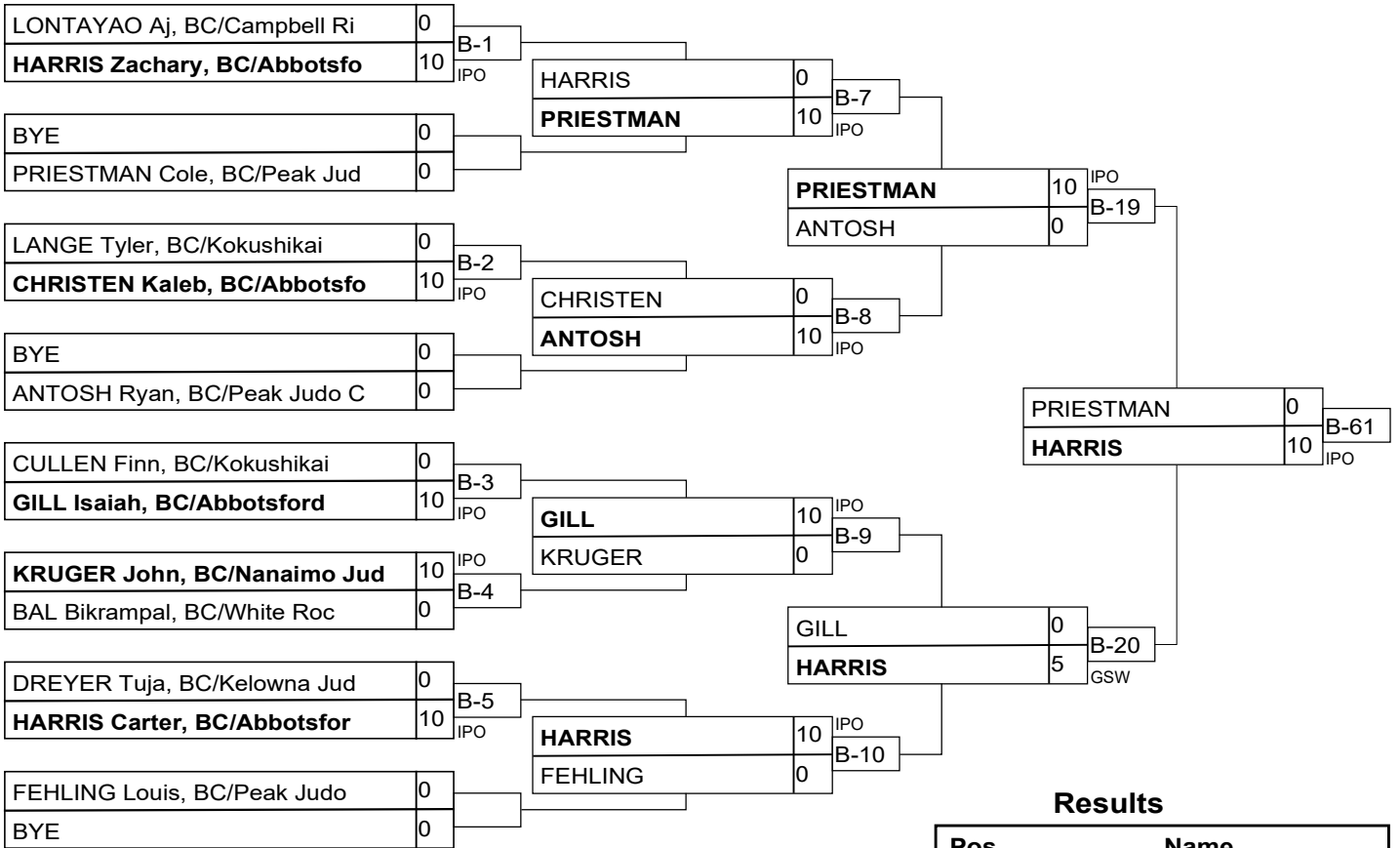

Results

Pos	Name
1	HARRIS Carter, BC/Abbots
2	PRIESTMAN Cole, BC/Peak
3	FEHLING Louis, BC/Peak J
3	GILL Isaiah, BC/Abbotsfo

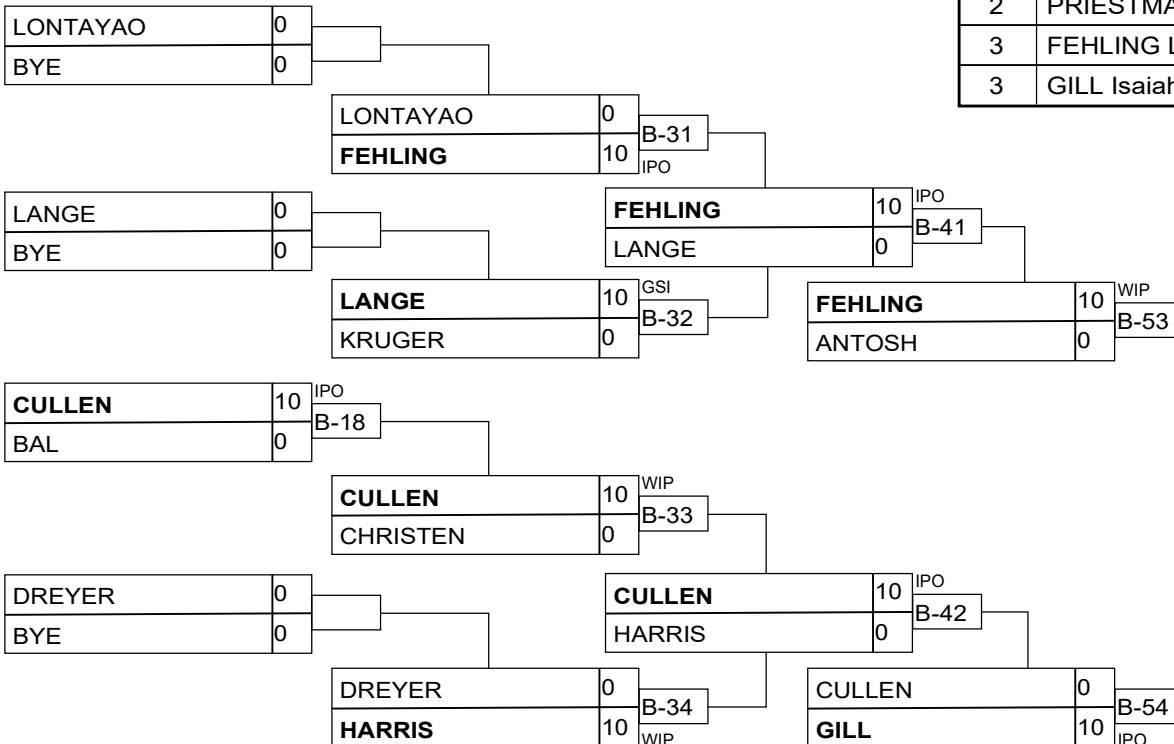

U18 Male -81kg

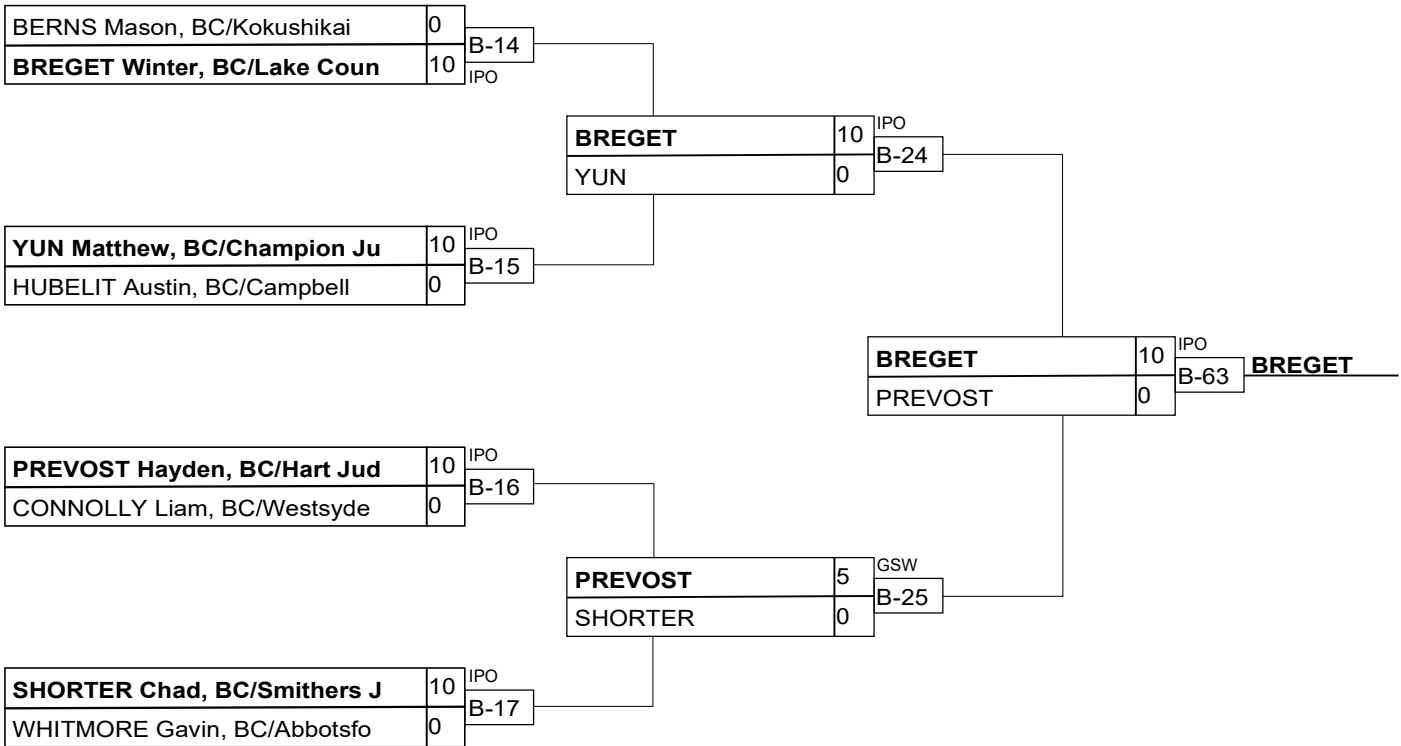

Results

Pos	Name
1	BREGET Winter, BC/Lake C
2	PREVOST Hayden, BC/Hart
3	YUN Matthew, BC/Champion
3	HUBELIT Austin, BC/Campb

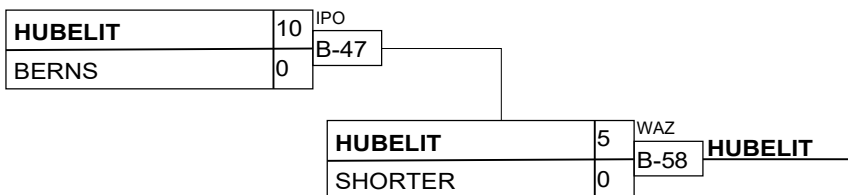
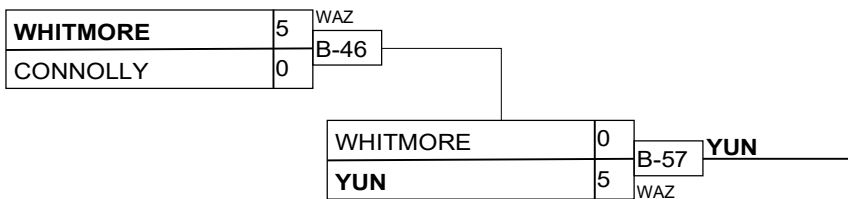

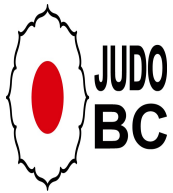

U21 Female -57kg



Competitors

#	Name	Grade	Club	1	2	3	4	5	Wins	Pts	Pos
1	ZHANG Liwen	Brown	BC/Police Judo Junior	XX					0	0	5
2	GREENE Isabella	Shodan	BC/Nanaimo Judo Club	10	XX			10	2	20	3
3	LOLIEVA Rakiia	Shodan	BC/Peak Judo Club	10	10	XX	5	10	4	35	1
4	DANILKOV Klavdia	Shodan	BC/Steveston Judo Club	10	10		XX	10	3	30	2
5	SHEARER Lola	Brown	BC/Steveston Judo Club	10				XX	1	10	4

Matches

Match	White	Blue	Result	Time	Code
C-5	DANILKOV Klavdia	4 5 SHEARER Lola	10 - 0	1:22	IPO
C-10	ZHANG Liwen	1 2 GREENE Isabella	0 - 10	4:49	GSW
C-22	LOLIEVA Rakiia	3 4 DANILKOV Klavdia	5 - 0	4:00	WAZ
C-24	ZHANG Liwen	1 5 SHEARER Lola	0 - 10	0:24	DHM
C-30	GREENE Isabella	2 3 LOLIEVA Rakiia	0 - 10	1:05	IPO
C-31	ZHANG Liwen	1 4 DANILKOV Klavdia	0 - 10	1:50	FUS
C-57	LOLIEVA Rakiia	3 5 SHEARER Lola	10 - 0	0:00	KIK
C-58	GREENE Isabella	2 4 DANILKOV Klavdia	0 - 10	3:15	IPO
C-59	ZHANG Liwen	1 3 LOLIEVA Rakiia	0 - 10	0:00	KIK
C-60	GREENE Isabella	2 5 SHEARER Lola	10 - 0	0:00	FUS

Results

Pos	Name
1	LOLIEVA Rakiia, BC/Peak Judo Club
2	DANILKOV Klavdia, BC/Steveston Judo Club
3	GREENE Isabella, BC/Nanaimo Judo Club
4	SHEARER Lola, BC/Steveston Judo Club

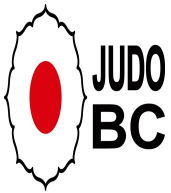

U21 Female -70kg



Competitors

#	Name	Grade	Club	1	2	1	2	1	2	Wins	Pts	Pos
1	MORISHO Nyota	Shodan	BC/Kokushikai Judo	XX	10	XX	10	XX		2	20	1
2	RUSSELL Judith	Blue	BC/Victoria Judo Club		XX		XX		XX	0	0	2

Matches

Match	White			Blue	Result	Time	Code
C-23	MORISHO Nyota	1	2	RUSSELL Judith	10 - 0	0:20	IPO
C-29	RUSSELL Judith	2	1	MORISHO Nyota	0 - 10	0:13	IPO
C-39	MORISHO Nyota	1	2	RUSSELL Judith			

Results

Pos	Name
1	MORISHO Nyota, BC/Kokushikai Judo

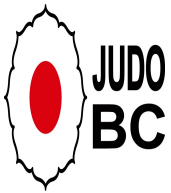

U21 Male -100kg



Competitors

#	Name	Grade	Club	1	2	1	2	1	2	Wins	Pts	Pos
1	NETTLES Dashiell	Blue	BC/Kamloops Judo Club	XX		XX		XX		0	0	2
2	TAMAYOSE Ryu	Blue/Brown	BC/Steveston Judo Club	10	XX	10	XX		XX	2	20	1

Matches

Match	White		Blue		Result	Time	Code
B-33	NETTLES Dashiell	1	2	TAMAYOSE Ryu	0 - 10	0:31	WIP
B-49	TAMAYOSE Ryu	2	1	NETTLES Dashiell	10 - 0	0:47	WIP
B-53	NETTLES Dashiell	1	2	TAMAYOSE Ryu			

Results

Pos	Name
1	TAMAYOSE Ryu, BC/Steveston Judo Club

U21 Male -60kg

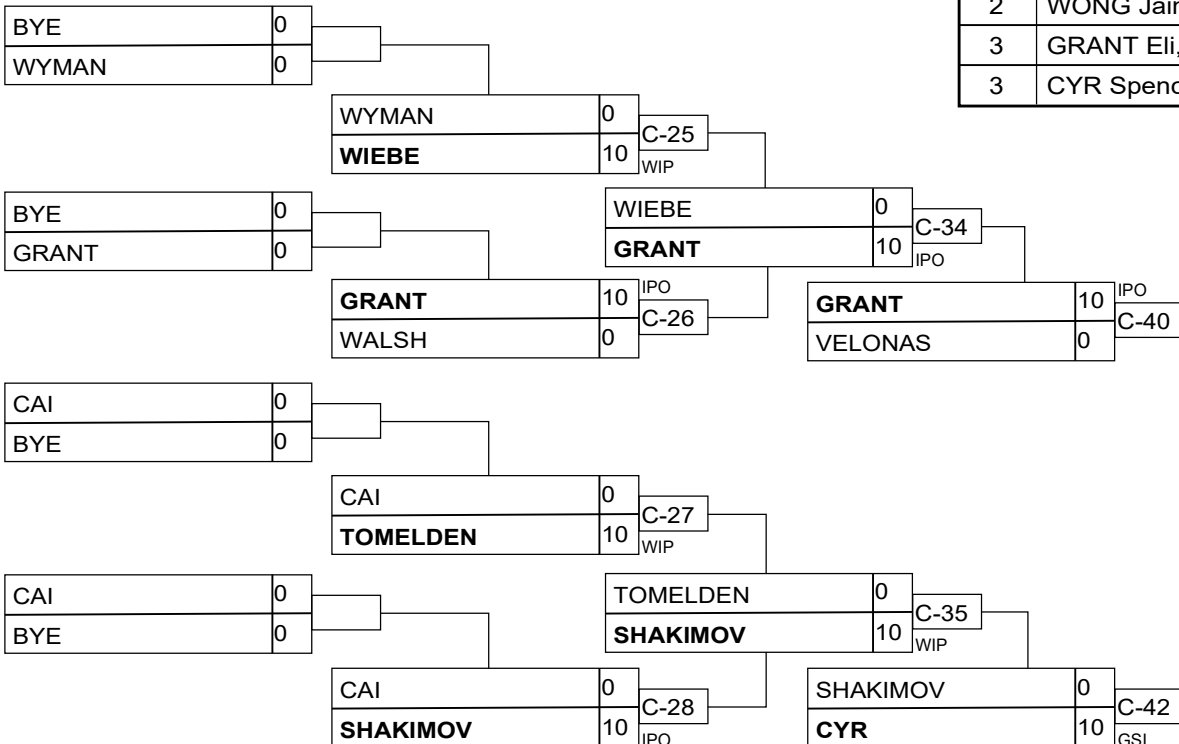
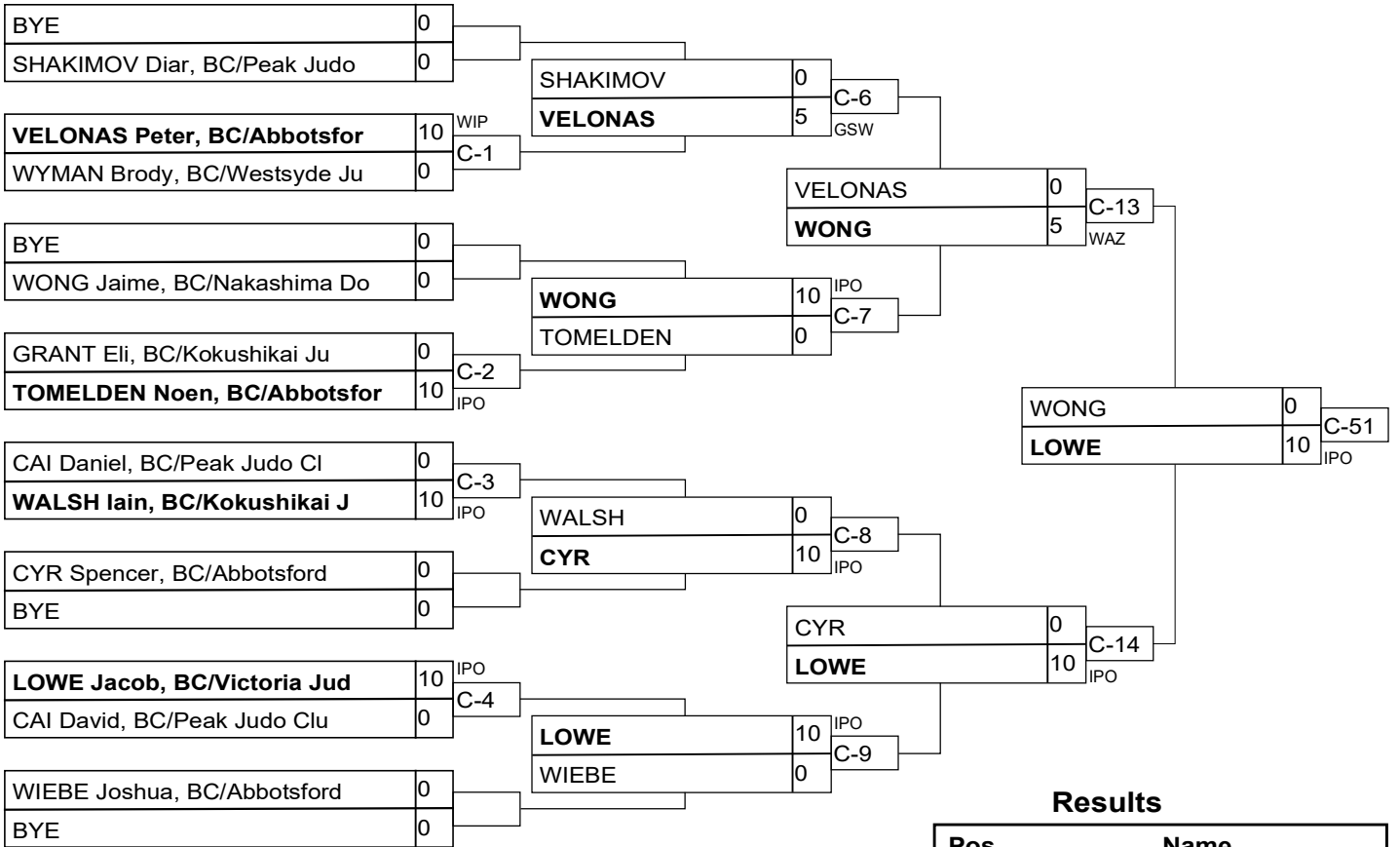

U21 Male -66kg

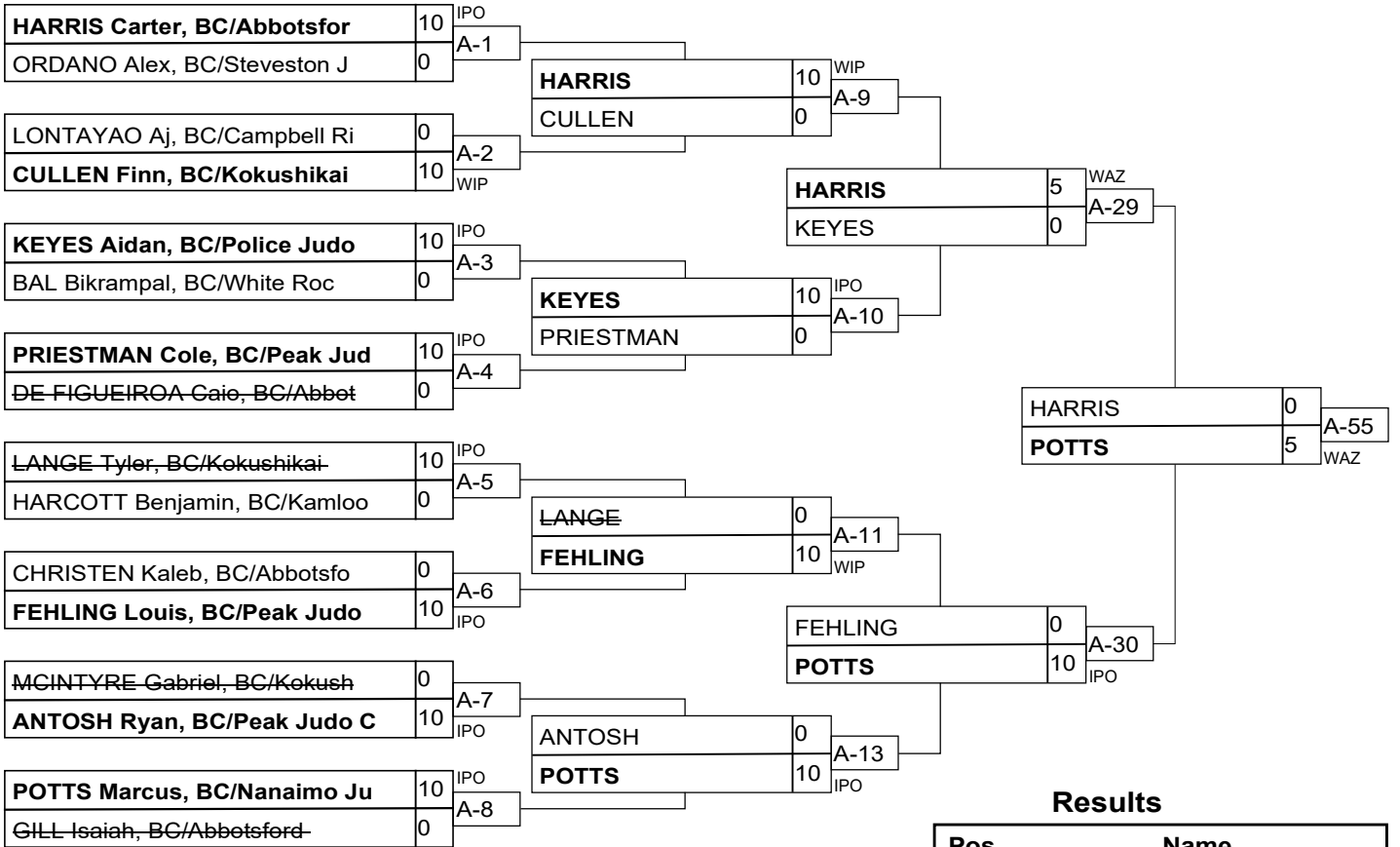

Pos	Name
1	POTTS Marcus, BC/Nanaimo
2	HARRIS Carter, BC/Abbots
3	ORDANO Alex, BC/Stevesto
3	FEHLING Louis, BC/Peak J

U21 Male -81kg

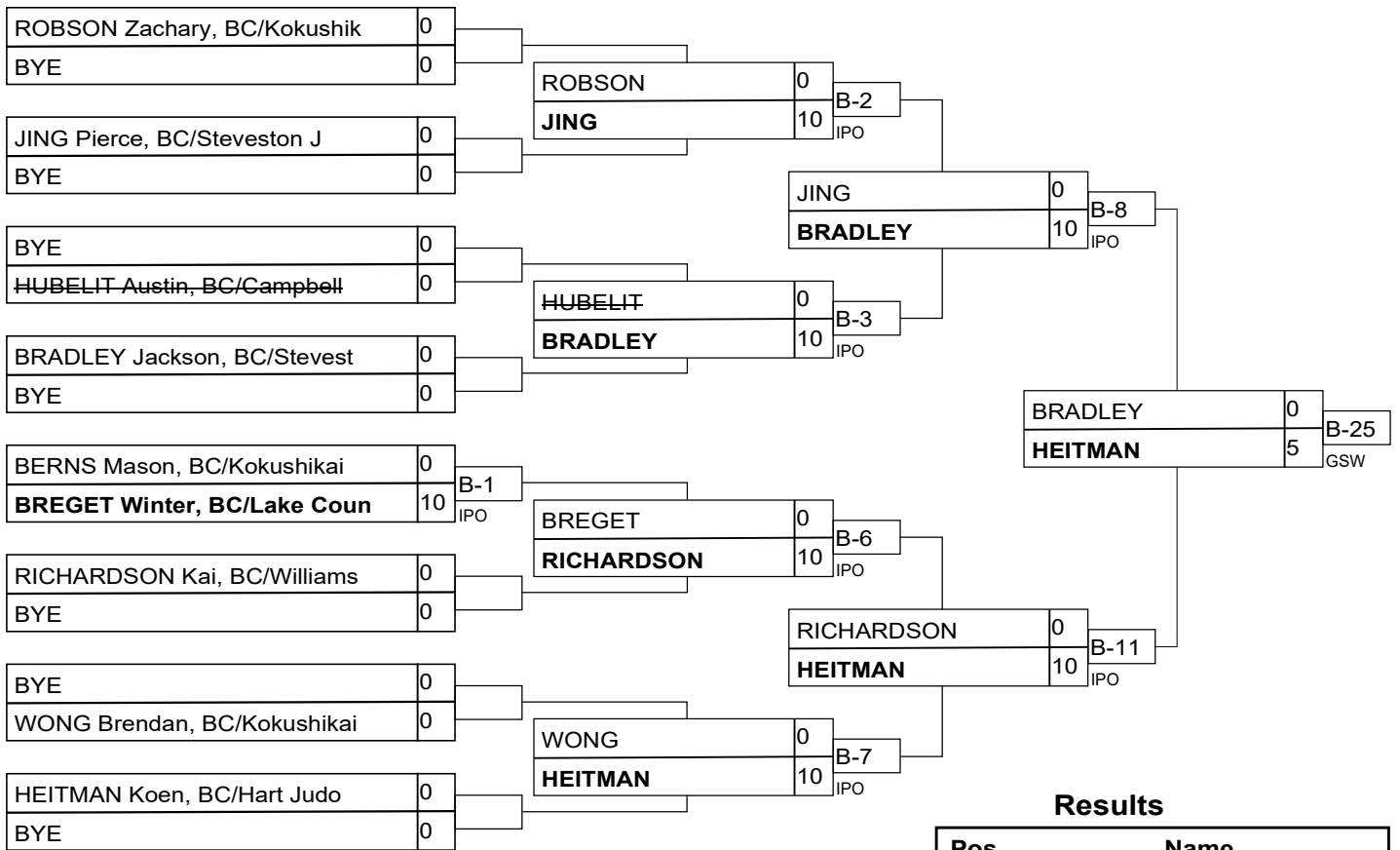

Results

Pos	Name
1	HEITMAN Koen, BC/Hart Ju
2	BRADLEY Jackson, BC/Stev
3	WONG Brendan, BC/Kokushi
3	RICHARDSON Kai, BC/Willi

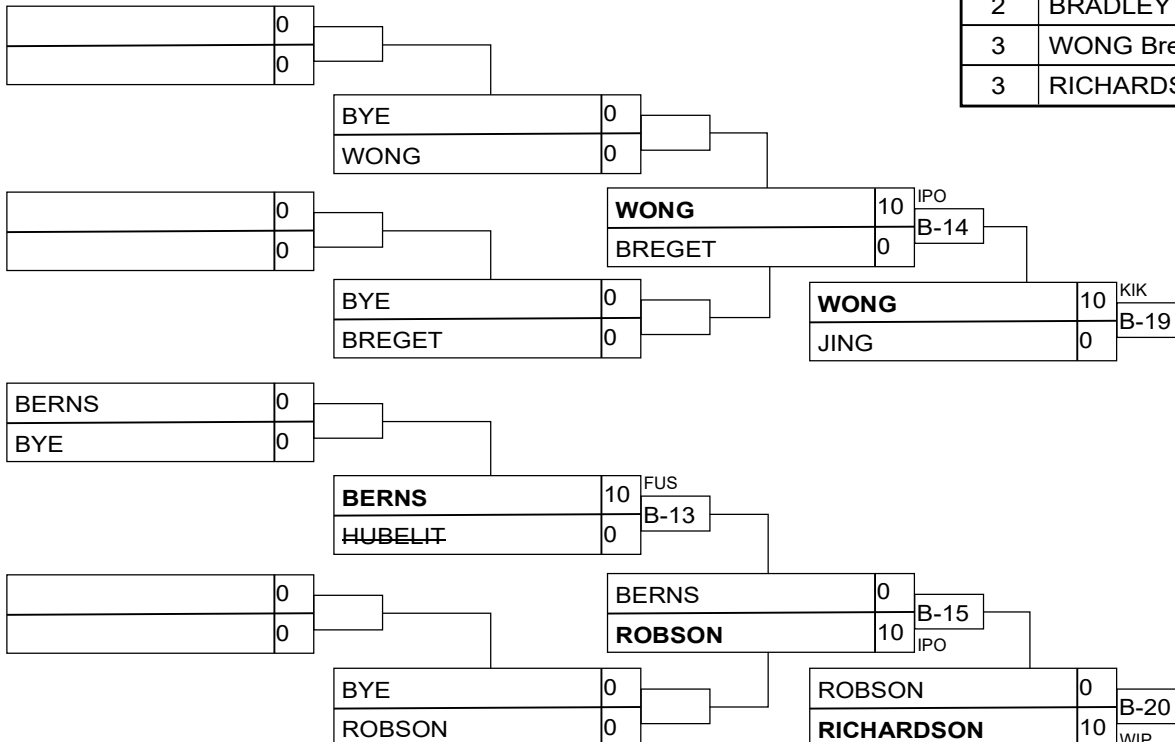

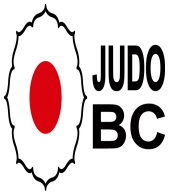

U21 Male +100kg



Competitors

#	Name	Grade	Club	1	2	1	2	1	2	Wins	Pts	Pos
1	FERSHAU Asher	Blue	BC/Abbotsford Judo Club	XX		XX		XX		0	0	2
2	VELASQUEZ KASAP Abel	Green	BC/Police Judo Junior	10	XX	10	XX		XX	2	20	1

Matches

Match	White		Blue		Result	Time	Code
B-34	FERSHAU Asher	1	2	VELASQUEZ KASAP Abel	0 - 10	1:18	IPO
B-48	VELASQUEZ KASAP Abel	2	1	FERSHAU Asher	10 - 0	0:51	IPO
B-52	FERSHAU Asher	1	2	VELASQUEZ KASAP Abel			

Results

Pos	Name
1	VELASQUEZ KASAP Abel, BC/Police Judo Junior